



HIT-HY 200-A/R INJECTION MORTAR

Technical Datasheet







Update: Nov-20













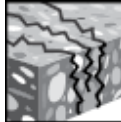
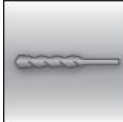

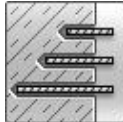
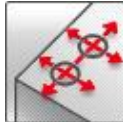
HIT-HY 200 injection mortar

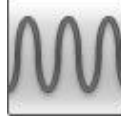
Anchor design (EN 1992-4) / Rods&Sleeves / Concrete

Injection mortar system	Benefits
 <p>Hilti HIT- HY 200-A 500 ml foil pack (also available as 330 ml foil pack)</p>	<ul style="list-style-type: none"> - SafeSet technology: Simplified method of borehole preparation using either Hilti hollow drill bit for hammer drilling or Roughening tool for diamond cored applications
 <p>Hilti HIT- HY 200-R, HIT- HY 200-R V3 500 ml foil pack (also available as 330 ml foil pack)</p>	<ul style="list-style-type: none"> - Suitable for non-cracked and cracked concrete C 20/25 to C 50/60 - ETA Approved for seismic performance category C1, C2^{a)}
 <p>Anchor rod: HAS-U HAS-U HDG HAS-U A4 HAS-U HCR (M8-M30)</p>	<ul style="list-style-type: none"> - Maximum load performance in cracked concrete and non-cracked concrete - 100 years service lifetime resistance^{b)}
 <p>Internally threaded sleeve: HIS-N HIS-RN (M8-M20)</p>	<ul style="list-style-type: none"> - Small edge distance and anchor spacing possible - Manual cleaning for borehole diameter up to 20mm and $h_{ef} \leq 10d$ for non-cracked concrete only
 <p>Anchor rod: HIT-Z HIT-Z-F HIT-Z-R (M8-M20)</p>	<ul style="list-style-type: none"> - Three mortar versions: HY-200-R and HY-200-R V3 for slow cure applications and HY 200-A for fast cure applications
 <p>Anchor rod: HAS-D (M12-M20)</p>	

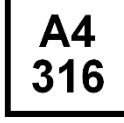
a) HIS-N internally threaded sleeves not approved for Seismic.
b) Only HIT-Z anchor rod has this feature.

Base material			Installation conditions					
 <p>Concrete (uncracked)</p>	 <p>Concrete (cracked)</p>	<p>100 YEARS 100 Years Design Life</p>	 <p>Hammer drilled holes</p>	 <p>Diamond drilled holes^{c)}</p>	<p>SAFE-SET Hilti SafeSet technology</p>	 <p>Variable embedment depth</p>	 <p>Small edge distance and spacing</p>	
Load conditions			Other information					
 <p>Static/quasi-static</p>	 <p>Seismic, ETA-C1, C2^{a)}</p>	 <p>Fatigue ETA^{d)}</p>	 <p>Fire resistance</p>	 <p>European Technical Assessment</p>	 <p>CE conformity</p>	 <p>Corrosion resistance^{b)}</p>	 <p>High corrosion resistance^{b)}</p>	 <p>PROFIS Engineering Design Software</p>

a) HIS-N internally threaded sleeves not approved for Seismic category C2.
b) High Corrosion resistant rods available only for HAS-U. Corrosion resistant rods available for HAS-U and HIS-N.
c) Diamond drilling covered for HIT-Z rods. Diamond drilling only with Roughening Tool (RT) for HAS-U and HIS-N.
d) Only for HAS-D rods.

Approvals / certificates

Description	Product	Authority / Laboratory	No. / date of issue
European Technical Assessment ^{a)}	HY 200-A (Anchor)	DIBt, Berlin	ETA-11/0493 / 2019-08-30
European Technical Assessment ^{a)}	HY 200-A (HIT-Z)	DIBt, Berlin	ETA-12/0006 / 2020-10-28
European Technical Assessment ^{a)}	HY 200-R (Anchor)	DIBt, Berlin	ETA-12/0084 / 2019-08-28
European Technical Assessment ^{a)}	HY 200-R V3 (HIT-Z)	DIBt, Berlin	ETA-19/0632 / 2020-10-28
European Technical Assessment ^{a)}	HY 200-R (HIT-Z)	DIBt, Berlin	ETA-12/0028 / 2020-10-28
European Technical Assessment ^{a)}	HY 200-A/R/R V3 (HAS-D)	DIBt, Berlin	ETA-18/0972 / 2020-05-13
European Technical Assessment ^{a)}	HY 200-A/R/R V3 (HAS-D)	DIBt, Berlin	ETA-18/0978 / 2020-05-13
European Technical Assessment ^{a)}	HY 200-A (HIT-Z-D)	DIBt, Berlin	ETA-15/0296 / 2020-05-13
European Technical Assessment ^{a)}	HY 200-A (HIT-Z-D)	DIBt, Berlin	ETA-15/0802 / 2020-04-15
Shockproof fastenings in civil defence installations	HY 200-A/R	Federal Office for Civil Protection, Bern	BZS D 13-604 / 2013-12-31 BZS D 13-603 / 2013-12-31
Fire test report	HY 200-A/R	IBMB, Brunswick	3502/676/12 / 2017-09-15

a) All data given in this section according to the ETA approval for the product.

Static and quasi-static resistance (for a single anchor)

All data in this section applies to:

- Correct setting (See setting instruction)
- No edge distance and spacing influence
- Steel failure
- Minimum base material thickness
- One typical embedment depth, as specified in the table
- One anchor material, as specified in the tables
- Concrete C 20/25
- Temperature range I (min. base material temp. -40°C, max. long/short term base material temp.: +24°C/40°C)
- Short term loading. For long term loading please apply $\psi_{sus} = 0.74^{b)}$

b) HIT-Z and HAS-D are suitable for permanent loading without any load reduction. ψ_{sus} is not considered for this element.

For hammer drilled holes, hammer drilled holes with Hilti hollow drill bit:

Anchorage depth ¹⁾

Anchor size		M8	M10	M12	M16	M20	M24	M27	M30
HAS-U									
Embedment depth	[mm]	80	90	110	125	170	210	240	270
Base material thickness	[mm]	110	120	140	160	220	270	300	340
HIS-N									
Embedment depth	[mm]	90	110	125	170	205	-	-	-
Base material thickness	[mm]	120	150	170	230	270	-	-	-
HIT-Z									
Embedment depth	[mm]	70	90	110	145	180	-	-	-
Base material thickness	[mm]	130	150	170	245	280	-	-	-
HAS-D									
Embedment depth	[mm]	-	-	100	125	170	-	-	-
Base material thickness	[mm]	-	-	130	160	220	-	-	-

1) The allowed range of embedment depth is shown in the setting details.



Characteristic resistance

Anchor size		M8	M10	M12	M16	M20	M24	M27	M30
Uncracked concrete									
Tension N_{Rk}	HAS-U 5.8	18,0	29,0	42,0	68,7	109	150	183	218
	HAS-U 8.8	29,0	42,0	56,8	68,7	109	150	183	218
	HAS-U A4	26,0	41,0	56,8	68,7	109	150	183	218
	HAS-U HCR	29,0	42,0	56,8	68,7	109	150	183	218
	HIS-N 8.8	25,0	46,0	67,0	109	116	-	-	-
	HIT-Z ^{a)}	24,0	38,0	50,0	85,9	118,8	-	-	-
	HAS-D	-	-	49,2	68,8	109	-	-	-
Shear V_{Rk}	HAS-U 5.8	9,0	15,0	21,0	39,0	61,0	88,0	115	140
	HAS-U 8.8	15,0	23,0	34,0	63,0	98,0	141	184	224
	HAS-U A4	13,0	20,0	30,0	55,0	86,0	124	115	140
	HAS-U HCR	15,0	23,0	34,0	63,0	98,0	124	161	196
	HIS-N 8.8	13,0	23,0	34,0	63,0	58,0	-	-	-
	HIT-Z ^{a)}	12,0	19,0	27,0	48,0	73,0	-	-	-
	HAS-D	-	-	34,0	63,0	149	-	-	-
Cracked concrete									
Tension N_{Rk}	HAS-U 5.8	15,1	21,2	35,2	48,1	76,3	105	128	153
	HAS-U 8.8	15,1	21,2	35,2	48,1	76,3	105	128	153
	HAS-U A4	15,1	21,2	35,2	48,1	76,3	105	128	153
	HAS-U HCR	15,1	21,2	35,2	48,1	76,3	105	128	153
	HIS-N 8.8	24,7	39,7	48,1	76,3	101	-	-	-
	HIT-Z ^{a)}	20,2	29,4	39,7	60,1	83,2	-	-	-
	HAS-D	-	-	34,4	48,1	76,3	-	-	-
Shear V_{Rk}	HAS-U 5.8	9,0	15,0	21,0	39,0	61,0	88,0	115	140
	HAS-U 8.8	15,0	23,0	34,0	63,0	98,0	141	184	224
	HAS-U A4	13,0	20,0	30,0	55,0	86,0	124	115	140
	HAS-U HCR	15,0	23,0	34,0	63,0	98,0	124	161	196
	HIS-N 8.8	13,0	23,0	34,0	63,0	58,0	-	-	-
	HIT-Z ^{a)}	12,0	19,0	27,0	48,0	73,0	-	-	-
	HAS-D	-	-	34,0	63,0	149	-	-	-

a) Hilti anchor rod HIT-Z-F: M16 and M20.

Design resistance

Anchor size		M8	M10	M12	M16	M20	M24	M27	M30
Uncracked concrete									
Tension N_{Rd}	HAS-U 5.8	12,0	19,3	28,0	45,8	72,7	99,8	122	146
	HAS-U 8.8	19,3	28,0	37,8	45,8	72,7	99,8	122	146
	HAS-U A4	13,9	21,9	31,6	45,8	72,7	99,8	80,4	98,3
	HAS-U HCR	19,3	28,0	37,8	45,8	72,7	99,8	122	146
	HIS-N 8.8	16,7	30,7	44,7	72,7	77,3	-	-	-
	HIT-Z ^{a)}	16,0	25,3	33,3	57,3	79,2	-	-	-
	HAS-D	-	-	32,8	45,8	72,7	-	-	-
Shear V_{Rd}	HAS-U 5.8	7,2	12,0	16,8	31,2	48,8	70,4	92,0	112
	HAS-U 8.8	12,0	18,4	27,2	50,4	78,4	113	147	179
	HAS-U A4	8,3	12,8	19,2	35,3	55,1	79,5	48,3	58,8
	HAS-U HCR	12,0	18,4	27,2	50,4	78,4	70,9	92,0	112
	HIS-N 8.8	10,4	18,4	27,2	50,4	46,4	-	-	-
	HIT-Z ^{a)}	9,6	15,2	21,6	38,4	58,4	-	-	-
	HAS-D	-	-	27,2	50,4	119	-	-	-
Cracked concrete									
Tension N_{Rd}	HAS-U 5.8	10,1	14,1	23,5	32,1	50,9	69,9	85,4	102
	HAS-U 8.8	10,1	14,1	23,5	32,1	50,9	69,9	85,4	102
	HAS-U A4	10,1	14,1	23,5	32,1	50,9	69,9	80,4	98,3
	HAS-U HCR	10,1	14,1	23,5	32,1	50,9	69,9	85,4	102
	HIS-N 8.8	16,5	26,5	32,1	50,9	67,4	-	-	-
	HIT-Z ^{a)}	13,4	19,6	26,5	40,1	55,4	-	-	-
	HAS-D	-	-	22,9	32,1	50,9	-	-	-
Shear V_{Rd}	HAS-U 5.8	7,2	12,0	16,8	31,2	48,8	70,4	92,0	112
	HAS-U 8.8	12,0	18,4	27,2	50,4	78,4	113	147	179
	HAS-U A4	8,3	12,8	19,2	35,3	55,1	79,5	48,3	58,8
	HAS-U HCR	12,0	18,4	27,2	50,4	78,4	70,9	92,0	112
	HIS-N 8.8	10,4	18,4	27,2	50,4	46,4	-	-	-
	HIT-Z ^{a)}	9,6	15,2	21,6	38,4	58,4	-	-	-
	HAS-D	-	-	27,2	50,4	102	-	-	-

a) Hilti anchor rod HIT-Z-F: M16 and M20.



Recommended loads

Anchor size		M8	M10	M12	M16	M20	M24	M27	M30
Uncracked concrete									
Tension N_{Rd}	HAS-U 5.8	8,6	13,8	20,0	32,7	51,9	71,3	87,1	104
	HAS-U 8.8	13,8	20,0	27,0	32,7	51,9	71,3	87,1	104
	HAS-U A4	9,9	15,7	22,5	32,7	51,9	71,3	57,4	70,2
	HAS-U HCR	13,8	20,0	27,0	32,7	51,9	71,3	87,1	104
	HIS-N 8.8	11,9	21,9	31,9	51,9	55,2	-	-	-
	HIT-Z	11,4	18,1	23,8	40,9	56,6	-	-	-
	HAS-D	-	-	23,4	32,7	51,9	-	-	-
Shear V_{Rd}	HAS-U 5.8	5,1	8,6	12,0	22,3	34,9	50,3	65,7	80,0
	HAS-U 8.8	8,6	13,1	19,4	36,0	56,0	80,6	105	128
	HAS-U A4	6,0	9,2	13,7	25,2	39,4	56,8	34,5	42,0
	HAS-U HCR	8,6	13,1	19,4	36,0	56,0	50,6	65,7	80,0
	HIS-N 8.8	7,4	13,1	19,4	36,0	33,1	-	-	-
	HIT-Z	6,9	10,9	15,4	27,4	41,7	-	-	-
	HAS-D	-	-	19,4	36,0	85,1	-	-	-
Cracked concrete									
Tension N_{Rd}	HAS-U 5.8	7,2	10,1	16,8	22,9	36,3	49,9	61,0	72,7
	HAS-U 8.8	7,2	10,1	16,8	22,9	36,3	49,9	61,0	72,7
	HAS-U A4	7,2	10,1	16,8	22,9	36,3	49,9	57,4	70,2
	HAS-U HCR	7,2	10,1	16,8	22,9	36,3	49,9	61,0	72,7
	HIS-N 8.8	11,8	18,9	22,9	36,3	48,1	-	-	-
	HIT-Z	9,6	14,0	18,9	28,6	39,6	-	-	-
	HAS-D	-	-	16,4	22,9	36,3	-	-	-
Shear V_{Rd}	HAS-U 5.8	5,1	8,6	12,0	22,3	34,9	50,3	65,7	80,0
	HAS-U 8.8	8,6	13,1	19,4	36,0	56,0	80,6	105	128
	HAS-U A4	6,0	9,2	13,7	25,2	39,4	56,8	34,5	42,0
	HAS-U HCR	8,6	13,1	19,4	36,0	56,0	50,6	65,7	80,0
	HIS-N 8.8	7,4	13,1	19,4	36,0	48,1	-	-	-
	HIT-Z	6,9	10,9	15,4	27,4	41,7	-	-	-
	HAS-D	-	-	19,4	36,0	72,7	-	-	-

Fatigue resistance

All data in this section applies to:

- Correct setting (See setting instruction)
- No edge distance and spacing influence
- Minimum base material thickness
- Concrete C 20/25
- Temperature range I (min. base material temp. -40°C, max. long/short term base material temp.: +24°C/40°C)

Anchorage depth

Anchor size		M12	M16	M20
HAS-D				
Embedment depth	[mm]	100	125	170
Base material thickness	[mm]	130	160	220
HIT-Z-D TP, HIT-Z-R-D TP				
Embedment depth	[mm]	-	125	-
Base material thickness	[mm]	-	160/225	-

Characteristic resistance under tension, shear and combined fatigue load in concrete (design method II acc. to TR 061) for HAS-D

Anchor size		M12	M16	M20
Tension fatigue load				
Steel failure				
Characteristic resistance	$\Delta N_{Rk,s,0,\infty}$ [kN]	20,1	34,0	43,5
Partial factor	$\gamma_{Ms,N,fat}$ [-]	1,35		
Concrete failure				
Effective embedment depth	h_{ef} [mm]	100	125	170
Reduction factor ¹⁾	$\eta_{k,c,N,fat,\infty}$ [-]	0,693		
Partial factor	$\gamma_{Mc,fat}$ [-]	1,5		
Load transfer factor for fastener group	ψ_{FN} [-]	0,79		
Shear fatigue load				
Steel failure				
Characteristic resistance	$\Delta V_{Rk,s,0,\infty}$ [kN]	8,2	15,0	21,1
Partial factor	$\gamma_{Ms,V,fat}$ [-]	1,35		
Concrete failure				
Effective length of fastener	l_f [mm]	100	125	170
Effective outside diameter of fastener	d_{nom} [mm]	14	18	24
Reduction factor ¹⁾	$\eta_{k,c,V,fat,\infty}$ [-]	0,652		
Partial factor	$\gamma_{Mc,fat}$ [-]	1,5		
Load transfer factor for fastener group	ψ_{FV} [-]	0,81		
Combined fatigue load				
Exponent for combined fatigue load	α_{sn} [-]	1,5		
	α_c [-]	1,5		

1) $\Delta N_{Rk,(c,sp),0,\infty} = \eta_{k,c,N,fat,\infty} \cdot N_{Rk,(c,sp)}$ with $N_{Rk,(c,sp)}$ according to ETA-18/0972; $\Delta V_{Rk,(c,cp),0,\infty} = \eta_{k,c,V,fat,\infty} \cdot V_{Rk,(c,cp)}$ with $V_{Rk,(c,cp)}$ according to ETA-18/0972.

Characteristic Wöhler curve under tension and shear fatigue load

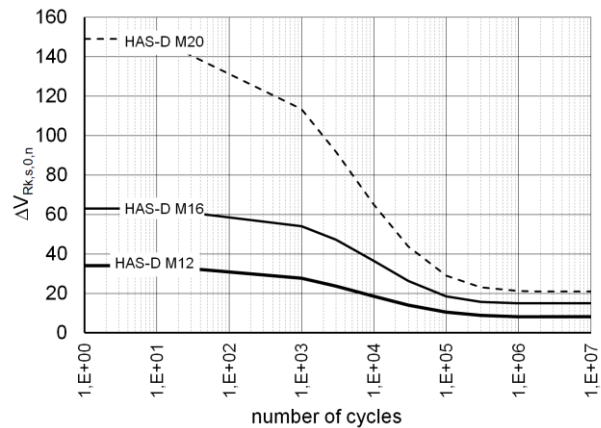
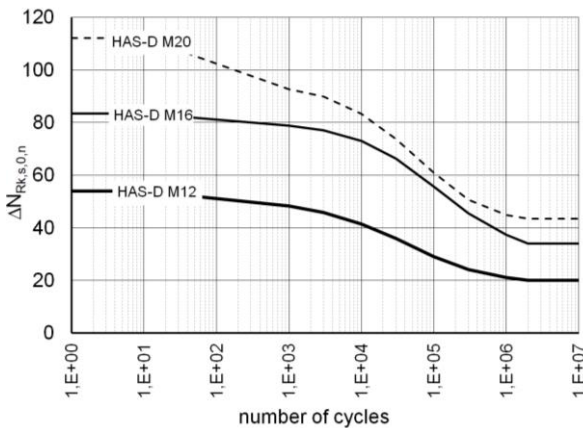

Characteristic resistance under tension, shear and combined fatigue load in concrete (design method II acc. to TR 061) for HIT-Z-(R)-D TP

Anchor size			M16
Tension fatigue load			
Steel failure			
Characteristic resistance HIT-Z-D TP	$\Delta N_{Rk,s,0,\infty}$	[kN]	18,8
Characteristic resistance HIT-Z-R-D TP	$\Delta N_{Rk,s,0,\infty}$	[kN]	12,4
Partial factor	$\gamma_{Ms,N,fat}$	[-]	1,35
Concrete failure			
Effective embedment depth	h_{ef}	[mm]	125
Reduction factor ¹⁾	$\eta_{k,c,N,fat,\infty}$	[-]	0,50
Partial factor	$\gamma_{Mc,fat}$	[-]	1,5
Load transfer factor for fastener group	ψ_{FN}	[-]	0,79
Shear fatigue load			
Steel failure			
Characteristic resistance HIT-Z-D TP	$\Delta V_{Rk,s,0,\infty}$	[kN]	8,0
Characteristic resistance HIT-Z-R-D TP	$\Delta V_{Rk,s,0,\infty}$	[kN]	8,0
Partial factor	$\gamma_{Ms,V,fat}$	[-]	1,35
Concrete failure			
Effective length of fastener	l_f	[mm]	125
Effective outside diameter of fastener	d_{nom}	[mm]	18
Reduction factor ¹⁾	$\eta_{k,c,V,fat,\infty}$	[-]	0,50
Partial factor	$\gamma_{Mc,fat}$	[-]	1,5
Load transfer factor for fastener group	ψ_{FV}	[-]	0,75
Combined fatigue load			
Exponent for combined fatigue load under steel failure HIT-Z-D TP	α_{sn}	[-]	1,4
Exponent for combined fatigue load under steel failure HIT-Z-R-D TP	α_{sn}	[-]	1,1
Exponent for combined fatigue load for concrete failure	α_c	[-]	1,5

1) $\Delta N_{Rk,(c,sp),0,\infty} = \eta_{k,c,N,fat,\infty} \cdot N_{Rk,(c,sp)}$ with $N_{Rk,(c,sp)}$ according to ETA-15/0296; $\Delta V_{Rk,(c,sp),0,\infty} = \eta_{k,c,V,fat,\infty} \cdot V_{Rk,(c,sp)}$ with $V_{Rk,(c,sp)}$ according to ETA-15/0296

Characteristic Wöhler curve under tension and shear fatigue load

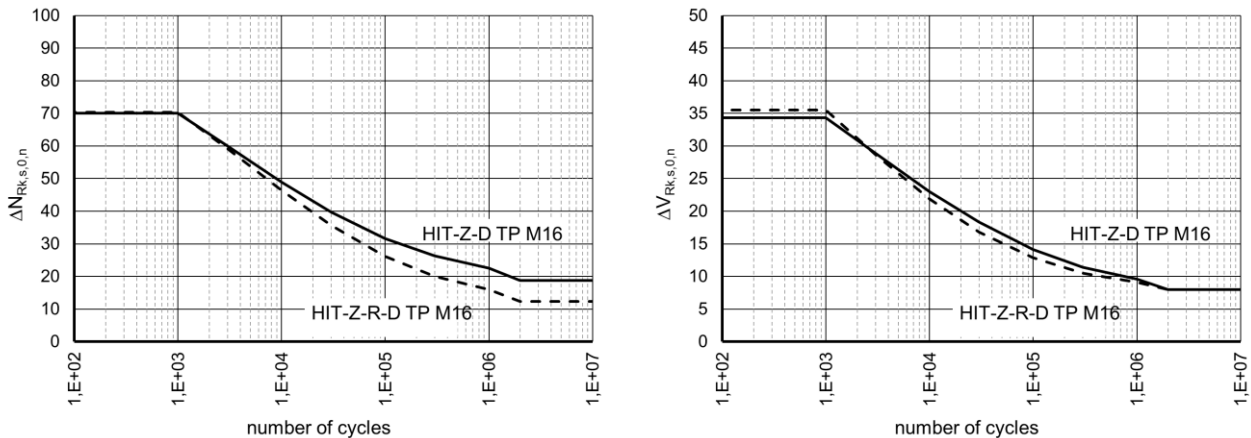

Seismic resistance (for a single anchor)

All data in this section applies to:

- Correct setting (See setting instruction with hammer drilling)
- No edge distance and spacing influence
- **Steel** failure
- Minimum base material thickness
- Concrete C 20/25
- Temperature range I (min. base material temp. -40°C , max. long/short term base material temp.: $+24^{\circ}\text{C}/40^{\circ}\text{C}$)
- Installation temperature range -10°C to $+40^{\circ}\text{C}$
- $\alpha_{\text{gap}} = 1,0$ (using Hilti seismic filling set)

For hammer drilled holes and hammer drilled holes with Hilti hollow drill bit:

Anchorage depth for seismic C2

Anchor size			M8	M10	M12	M16	M20	M24	M27	M30
HAS-U										
Embedment depth	h_{ef}	[mm]	-	-	-	125	170	210	-	-
HIT-Z										
Embedment depth	h_{ef}	[mm]	-	-	110	145	180	-	-	-
Base material thickness		[mm]	-	-	170	245	280	-	-	-

Characteristic resistance in case of seismic performance category C2

Anchor size		M8	M10	M12	M16	M20	M24	M27	M30
Tension $N_{Rk,seis}$	HAS-U 8.8 [kN]	-	-	-	24,5	45,9	55,4	-	-
	HIT-Z ^{a)}	-	-	22,0	51,1	70,7	-	-	-
Shear $V_{Rk,seis}$	HAS-U 8.8 w/ filling set [kN]	-	-	-	46,0	77,0	103	-	-
	HAS-U 8.8 w/o filling set [kN]	-	-	-	40,0	71,0	90,0	-	-
	HIT-Z ^{a)} w/ filling set [kN]	-	-	23,0	41,0	61,0	-	-	-

a) Hilti anchor rod HIT-Z-F: M16 and M20.

Design resistance in case of seismic performance category C2

Anchor size		M8	M10	M12	M16	M20	M24	M27	M30
Tension $N_{Rd,seis}$	HAS-U 8.8 [kN]	-	-	-	16,3	30,6	36,9	-	-
	HIT-Z ^{a)}	-	-	14,7	34,1	47,1	-	-	-
Shear $V_{Rd,seis}$	HAS-U 8.8 w/ filling set [kN]	-	-	-	36,8	61,6	82,4	-	-
	HAS-U 8.8 w/o filling set [kN]	-	-	-	32,0	56,8	72,0	-	-
	HIT-Z ^{a)} w/ filling set [kN]	-	-	18,4	32,8	48,8	-	-	-

a) Hilti anchor rod HIT-Z-F: M16 and M20.

Anchorage depth for seismic C1

Anchor size			M8	M10	M12	M16	M20	M24	M27	M30
HAS-U										
Embedment depth	h_{ef}	[mm]	-	90	110	125	170	210	240	270
HIT-Z										
Embedment depth	h_{ef}	[mm]	70	90	110	145	180	-	-	-
Base material thickness	h	[mm]	130	150	170	245	280	-	-	-

Characteristic resistance in case of seismic performance category C1

Anchor size			M8	M10	M12	M16	M20	M24	M27	M30
Tension $N_{Rk,seis}$	HAS-U 8.8	[kN]	-	14,7	29,0	44,0	72,5	99,6	122	145
	HIT-Z ^{a)} ; HIT-Z-R		17,1	25,0	33,8	51,1	70,7	-	-	-
Shear $V_{Rk,seis}$	HAS-U 8.8	[kN]	-	23,0	34,0	63,0	98,0	141	184	224
	HIT-Z ^{a)} ; HIT-Z-R		8,5	12,0	16,0	28,0	45,0	-	-	-

a) Hilti anchor rod HIT-Z-F: M16 and M20.

Design resistance in case of seismic performance category C1

Anchor size			M8	M10	M12	M16	M20	M24	M27	M30
Tension $N_{Rd,seis}$	HAS-U 8.8	[kN]	-	9,8	19,4	29,3	48,4	66,4	81,1	96,8
	HIT-Z ^{a)} ; HIT-Z-R		11,4	16,7	22,5	34,1	47,1	-	-	-
Shear $V_{Rd,seis}$	HAS-U 8.8	[kN]	-	18,4	27,2	50,4	78,4	113	145	173
	HIT-Z ^{a)} ; HIT-Z-R		6,8	9,6	12,8	22,4	36,0	-	-	-

a) Hilti anchor rod HIT-Z-F: M16 and M20.

Materials

Mechanical properties for HAS-U

Anchor size			M8	M10	M12	M16	M20	M24	M27	M30
Nominal tensile strength f_{uk}	HAS-U 5.8 (HDG)	[N/mm ²]	500	500	500	500	500	500	-	-
	HAS-U 8.8 (HDG)		800	800	800	800	800	800	800	800
	AM 8.8 (HDG)		700	700	700	700	700	700	500	500
	HAS-U A4		800	800	800	800	800	700	-	-
Yield strength f_{yk}	HAS-U 5.8 (HDG)	[N/mm ²]	440	440	440	440	400	400	-	-
	HAS-U 8.8 (HDG)		640	640	640	640	640	640	640	640
	AM 8.8 (HDG)		450	450	450	450	450	450	210	210
	HAS-U A4		640	640	640	640	640	400	-	-
Stressed cross-section A_s	HAS-U	[mm ²]	36,6	58,0	84,3	157	245	353	459	561
Moment of resistance W	HAS-U	[mm ³]	31,2	62,3	109	277	541	935	1387	1874

Mechanical properties for HIS-N

Anchor size		M8	M10	M12	M16	M20
Nominal tensile strength f_{uk}	HIS-N	490	490	490	490	490
	Screw 8.8	800	800	800	800	800
	HIS-RN	700	700	700	700	700
	Screw A4-70	700	700	700	700	700
Yield strength f_{yk}	HIS-N	390	390	390	390	390
	Screw 8.8	640	640	640	640	640
	HIS-RN	350	350	350	350	350
	Screw A4-70	450	450	450	450	450
Stressed cross-section A_s	HIS-(R)N	51,5	108	169	256	238
	Screw	36,6	58,0	84,3	157	245
Moment of resistance W	HIS-(R)N	145	430	840	1595	1543
	Screw	31,2	62,3	109	277	541

Mechanical properties for HIT-Z

Anchor size		M8	M10	M12	M16	M20
Nominal tensile strength f_{uk}	HIT-Z(-F) ^{a)}	650	650	650	610	595
	HIT-Z-R	650	650	650	610	595
Yield strength f_{yk}	HIT-Z(-F) ^{a)}	520	520	520	490	480
	HIT-Z-R	520	520	520	490	480
Stressed cross-section of thread A_s	HIT-Z(-F) ^{a)}	36,6	58,0	84,3	157	245
	HIT-Z-R	36,6	58,0	84,3	157	245
Moment of resistance W	HIT-Z(-F) ^{a)}	31,9	62,5	109,7	278	542
	HIT-Z-R	31,9	62,5	109,7	278	542

a) Hilti anchor rod HIT-Z-F: M16 and M20.



Material quality for HAS-U

Part	Material
Zinc coated steel	
Threaded rod, HAS-U 5.8 (HDG)	Strength class 5.8; Elongation at fracture A5 > 8% ductile Electroplated zinc coated $\geq 5\mu\text{m}$; (HDG) hot dip galvanized $\geq 45\mu\text{m}$
Threaded rod, HAS-U 8.8 (HDG)	Strength class 8.8; Elongation at fracture A5 > 12% ductile Electroplated zinc coated $\geq 5\mu\text{m}$; (HDG) hot dip galvanized $\geq 45\mu\text{m}$
Hilti Meter rod, AM 8.8 (HDG)	Strength class 8.8; Elongation at fracture A5 > 12% ductile Electroplated zinc coated $\geq 5\mu\text{m}$ (HDG) hot dip galvanized $\geq 45\mu\text{m}$
Washer	Electroplated zinc coated $\geq 5\mu\text{m}$, hot dip galvanized $\geq 45\mu\text{m}$
Nut	Strength class of nut adapted to strength class of threaded rod. Electroplated zinc coated $\geq 5\mu\text{m}$, (HDG) hot dip galvanized $\geq 45\mu\text{m}$
Hilti Filling set (F)	Filling washer: Electroplated zinc coated $\geq 5\mu\text{m}$ / (HDG) Hot dip galvanized $\geq 45\mu\text{m}$
	Spherical washer: Electroplated zinc coated $\geq 5\mu\text{m}$ / (HDG) Hot dip galvanized $\geq 45\mu\text{m}$
	Lock nut: Electroplated zinc coated $\geq 5\mu\text{m}$ / (HDG) Hot dip galvanized $\geq 45\mu\text{m}$
Stainless Steel	
Threaded rod, HAS-U A4	Strength class 70 for $\leq M24$ and strength class 50 for $> M24$; Elongation at fracture A5 > 8% ductile Stainless steel 1.4401; 1.4404; 1.4578; 1.4571; 1.4439; 1.4362 EN 10088-1:2014
Washer	Stainless steel 1.4401, 1.4404, 1.4578, 1.4571, 1.4439, 1.4362 EN 10088-1:2014
Nut	Stainless steel 1.4401, 1.4404, 1.4578, 1.4571, 1.4439, 1.4362 EN 10088-1:2014
High corrosion resistant steel	
Threaded rod, HAS-U HCR	Strength class 80 for $\leq M20$ and class 70 for $> M20$, Elongation at fracture A5 > 8% ductile High corrosion resistant steel 1.4529, 1.4565 EN 10088-1:2014
Washer	High corrosion resistant steel 1.4529, 1.4565 EN 10088-1:2014
Nut	High corrosion resistant steel 1.4529, 1.4565 EN 10088-1:2014

Material quality for HIS-N

Part	Material	
HIS-N	Int. threaded sleeve	Electroplated zinc coated $\geq 5\mu\text{m}$
	Screw 8.8	Strength class 8.8, A5 > 8 % Ductile; Steel galvanized $\geq 5\mu\text{m}$
HIS-RN	Int. threaded sleeve	Stainless steel 1.4401, 1.4571 EN 10088-1:2014
	Screw 70	Strength class 70, A5 > 8 % Ductile; Stainless steel 1.4401; 1.4404, 1.4578; 1.4571; 1.4439; 1.4362

Material quality for HIT-Z

Part	Material
Threaded rod HIT-Z	Elongation at fracture > 8% ductile; Electroplated zinc coated $\geq 5\mu\text{m}$
Washer	Electroplated zinc coated $\geq 5\mu\text{m}$
Nut	Strength class of nut adapted to strength class of anchor rod. Electroplated zinc coated $\geq 5\mu\text{m}$
HIT-Z-F	Elongation at fracture > 8% ductile Multilayer coating, ZnNi-galvanized according to DIN 50979:2008-07
Washer	Multilayer coating, ZnNi-galvanized according to DIN 50979:2008-07
Nut	Multilayer coating, ZnNi-galvanized according to DIN 50979:2008-07
HIT-Z-R	Elongation at fracture > 8% ductile; Stainless steel 1.4401, 1.4404 EN 10088-1:2014
Washer	Stainless steel A4 according to EN 10088-1:2014
Nut	Strength class of nut adapted to strength class of anchor rod. Stainless steel 1.4401, 1.4404 EN 10088-1:2014

Material quality for HAS-D

Part	Material
Fastener	Steel according to EN 10087:1998, galvanized and coated
Sealing washer	Steel, electroplated zinc coated $\geq 5 \mu\text{m}$
Calotte nut	Steel, electroplated zinc coated $\geq 5 \mu\text{m}$
Lock nut	Steel, electroplated zinc coated $\geq 5 \mu\text{m}$

Setting information

In service temperature range

Hilti HIT-HY 200 A (R) injection mortar with anchor rod HAS-U / HIS-(R)N may be applied in the temperature ranges given below. An elevated base material temperature leads to a reduction of the design bond resistance.

Temperature in the base material

Temperature range	Base material temperature	Maximum long term base material temperature	Maximum short term base material temperature
Temperature range I	-40 °C to +40 °C	+24 °C	+40 °C
Temperature range II	-40 °C to +80 °C	+50 °C	+80 °C
Temperature range III	-40 °C to +120 °C	+72 °C	+120 °C

Max short term base material temperature

Short-term elevated base material temperatures are those that occur over brief intervals, e.g. as a result of diurnal cycling.

Max long term base material temperature

Long-term elevated base material temperatures are roughly constant over significant periods of time.

Curing and working time

Temperature of the base material	HIT-HY 200-A		HIT-HY 200-R		HIT-HY 200-R V3	
	Maximum working time t_{work}	Minimum curing time t_{cure}	Maximum working time t_{work}	Minimum curing time t_{cure}	Maximum working time t_{work}	Minimum curing time t_{cure}
$-10^{\circ}\text{C} < T_{\text{BM}} \leq -5^{\circ}\text{C}$	1,5 h	7 h	3 h	20 h	3 h	20 h
$-5^{\circ}\text{C} < T_{\text{BM}} \leq 0^{\circ}\text{C}$	50 min	4 h	2 h	8 h	1,5 h	8 h
$0^{\circ}\text{C} < T_{\text{BM}} \leq 5^{\circ}\text{C}$	25 min	2 h	1 h	4 h	45 min	4 h
$5^{\circ}\text{C} < T_{\text{BM}} \leq 10^{\circ}\text{C}$	15 min	75 min	40 min	2,5 h	30 min	2,5 h
$10^{\circ}\text{C} < T_{\text{BM}} \leq 20^{\circ}\text{C}$	7 min	45 min	15 min	1,5 h	15 min	1,5 h
$20^{\circ}\text{C} < T_{\text{BM}} \leq 30^{\circ}\text{C}$	4 min	30 min	9 min	1 h	9 min	1 h
$30^{\circ}\text{C} < T_{\text{BM}} \leq 40^{\circ}\text{C}$	3 min	30 min	6 min	1 h	6 min	1 h

Setting details / Design parameters for HAS-U

Anchor size	M8	M10	M12	M16	M20	M24	M27	M30	
Nominal diameter of drill bit d_0 [mm]	10	12	14	18	22	28	30	35	
Eff. embedment depth and drill hole depth ^{a)}	$h_{ef,min}$ [mm]	60	60	70	80	90	96	108	120
	$h_{ef,max}$ [mm]	160	200	240	320	400	480	540	600
Minimum base material thickness	h_{min} [mm]	$h_{ef} + 30 \text{ mm} \geq 100 \text{ mm}$			$h_{ef} + 2 d_0$				
Maximum diameter of clearance hole in the fixture	d_f [mm]	9	12	14	18	22	26	30	33
Thickness of Hilti filling set	h_{fs} [mm]	-	-	-	11	13	15	-	-
Effective fixture thickness with Hilti filling set	$t_{fix,eff}$ [mm]	$t_{fix} - h_{fs}$							
Max. torque moment ^{b)}	T_{max} [Nm]	10	20	40	80	150	200	270	300
Minimum spacing	s_{min} [mm]	40	50	60	75	90	115	120	140
Minimum edge distance	c_{min} [mm]	40	45	45	50	55	60	75	80
Critical spacing for splitting failure	$s_{cr,sp}$ [mm]	$2 C_{cr,sp}$							
Critical edge distance for splitting failure ^{c)}	$C_{cr,sp}$ [mm]	$1,0 \cdot h_{ef}$ for $h / h_{ef} \geq 2,00$							
		$4,6 h_{ef} - 1,8 h$ for $2,0 > h / h_{ef} > 1,3$							
		$2,26 h_{ef}$ for $h / h_{ef} \leq 1,3$							
Critical spacing for concrete cone failure	$s_{cr,N}$ [mm]	$2 C_{cr,sp}$							
Critical edge distance for concrete cone failure	$C_{cr,N}$ [mm]	$1,5 h_{ef}$							

For spacing (edge distance) smaller than critical spacing (critical edge distance) the design loads have to be reduced.

a) $h_{ef,min} \leq h_{ef} \leq h_{ef,max}$ (h_{ef} : embedment depth).

b) Maximum recommended torque moment to avoid splitting failure during instalation with minimum spacing and edge distance.

c) h : base material thickness ($h \geq h_{min}$).

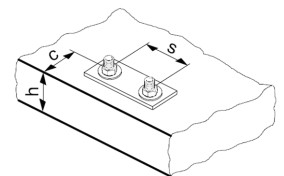

HAS-U-...



Marking:

Steel grade number and length identification letter: e.g. 8L

Setting details / Design parameters for HIS-N

Anchor size		M8	M10	M12	M16	M20
Nominal diameter of drill bit d_0	[mm]	14	18	22	28	32
Diameter of element d	[mm]	12,5	16,5	20,5	25,4	27,6
Effective anchorage and drill hole depth h_{ef}	[mm]	90	110	125	170	205
Minimum base material thickness h_{min}	[mm]	120	150	170	230	270
Diameter of clearance hole in the fixture d_f	[mm]	9	12	14	18	22
Thread engagement length; min - max h_s	[mm]	8-20	10-25	12-30	16-40	20-50
Minimum spacing s_{min}	[mm]	60	75	90	115	130
Minimum edge distance c_{min}	[mm]	40	45	55	65	90
Critical spacing for splitting failure $s_{cr,sp}$	[mm]	$2 C_{cr,sp}$				
Critical edge distance for splitting failure ^{a)} $c_{cr,sp}$	[mm]	$1,0 \cdot h_{ef}$ for $h / h_{ef} \geq 2,0$				
		$4,6 h_{ef} - 1,8 h$ for $2,0 > h / h_{ef} > 1,3$				
		$2,26 h_{ef}$ for $h / h_{ef} \leq 1,3$				
Critical spacing for concrete cone failure $s_{cr,N}$	[mm]	$2 C_{cr,N}$				
Critical edge distance for concrete cone failure $c_{cr,N}$	[mm]	$1,5 h_{ef}$				
Max. torque moment ^{b)} T_{max}	[Nm]	10	20	40	80	150

For spacing (edge distance) smaller than critical spacing (critical edge distance) the design loads have to be reduced.

a) h : base material thickness ($h \geq h_{min}$).

b) Max. recommended torque moment to avoid splitting failure during Installation with minimum spacing and edge distance.

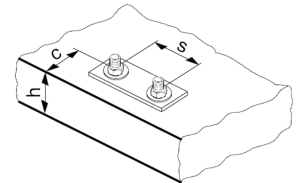
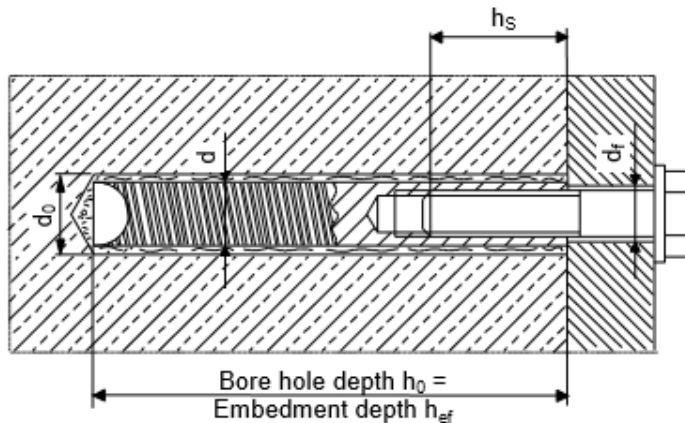

Setting details / Design parameters for HAS-D

Anchor size		M12	M16	M20
Nominal diameter of drill bit	d_0 [mm]	14	18	24
Diameter of element	$d = d_{nom}$ [mm]	12	16	20
Effective anchorage and drill hole depth	h_{ef} [mm]	100	125	170
Minimum drill hole depth	h_0 [mm]	105	133	180
Minimum base material thickness	h_{min} [mm]	130	160 ¹⁾ / 170	220 ¹⁾ / 230
Pre-setting:				
Maximum diameter of clearance hole in the fixture	d_f [mm]	14	18	24
Through-setting:				
Maximum diameter of clearance hole in the fixture	d_f [mm]	16	20	26
Fixture thickness	$t_{fix,min}$ [mm]	12	16	20
	$t_{fix,max}$ [mm]	200		
Installation torque moment	T_{inst} [Nm]	30	50	80
Uncracked concrete	Minimum spacing $s_{min,ucr}$ [mm]	80 ²⁾	60	80
	Minimum edge distance $c_{min,ucr}$ [mm]	55 ²⁾	60	80
Cracked concrete	Minimum spacing $s_{min,ucr}$ [mm]	50	60	80
	Minimum edge distance $c_{min,ucr}$ [mm]	50	60	80

1) The reverse side of the concrete member shall have no break-through after drilling.

2) For min. edge distance $c_{min} \geq 80$ mm, min. spacing $s_{min} = 55$ mm.

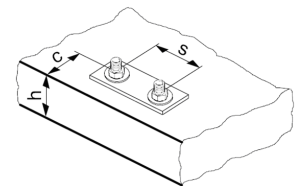
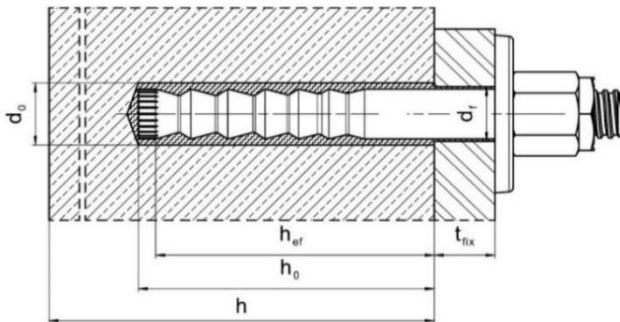

Anchor dimension for HAS-D

Anchor size		M12	M16	M20
Shaft diameter	d_k [mm]	12,5	16,5	22,0
Fastener length l	\geq [mm]	143	180	242
	\leq [mm]	531	565	623
Calotte nut	SW [mm]	18/19	24	30
Lock nut	SW [mm]	19	24	30

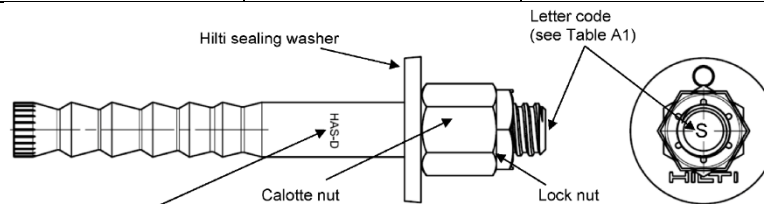

Marking:
HAS-D M...x L Bonded expansion anchor type as well as bonded expansion anchor size and length

Volume calculator app values per fastening point for HAS-D

Anchor size	M12	M16	M20
Anchor length [mm]	160	185	200
Volume [ml]	12,2	15,2	19,0

Setting details / Design parameters for HIT-Z, HIT-Z-F and HIT-Z-R

Anchor size	M8	M10	M12	M16	M20	
Nominal diameter of drill bit d_0 [mm]	10	12	14	18	22	
Length of anchor	min l [mm]	80	95	105	155	
	max l [mm]	120	160	196	420	
Nominal embedment depth range ^{a)}	$h_{nom,min}$ [mm]	60	60	60	96	
	$h_{nom,max}$ [mm]	100	120	144	192	
Borehole condition 1 Min. base material thickness	h_{min} [mm]	$h_{nom} + 60$ mm			$h_{nom} + 100$ mm	
Borehole condition 2 Min. base material thickness	h_{min} [mm]	$h_{nom} + 30$ mm ≥ 100 mm			$h_{nom} + 45$ mm ≥ 45 mm	
Maximum depth of drill hole	h_0 [mm]	$h - 30$ mm			$h - 2 d_0$	
Pre-setting: Diameter of clearance hole in the fixture	d_f [mm]	9	12	14	18	
Through-setting: Diameter of clearance hole in the fixture	d_f [mm]	11	14	16	20	
Maximum fixture thickness	t_{fix} [mm]	48	87	120	303	
Maximum fixture thickness with seismic filling set	t_{fix} [mm]	41	79	111	292	
Installation torque moment ^{b)}	HIT-Z, HIT-Z-F T_{inst} [Nm]	10	25	40	80	
	HIT-Z-R T_{inst} [Nm]	30	55	75	155	
Critical spacing for splitting failure	$s_{cr,sp}$ [mm]	$2 C_{cr,sp}$				
Critical edge distance for splitting failure ^{c)}	$c_{cr,sp}$ [mm]	$1,5 \cdot h_{nom}$		for $h / h_{nom} \geq 2,35$		
		$6,2 h_{nom} - 2,0 h$		for $2,35 > h / h_{nom} > 1,35$		
		$3,5 h_{nom}$		for $h / h_{nom} \leq 1,35$		
Critical spacing for concrete cone failure	$s_{cr,N}$ [mm]	$2 C_{cr,N}$				
Critical edge distance concrete cone failure	$c_{cr,N}$ [mm]	$1,5 h_{nom}$				

For spacing (edge distance) smaller than critical spacing (critical edge distance) the design loads have to be reduced.

a) $h_{nom,min} \leq h_{nom} \leq h_{nom,max}$ (h_{nom} : embedment depth).

b) Recommended torque moment to avoid splitting failure during installation with minimum spacing and edge distance.

c) h : base material thickness ($h \geq h_{min}$).

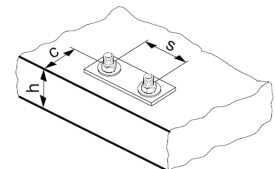
Pre-setting:

Install anchor before positioning fixture

Through-setting:

Install anchor through positioned fixture

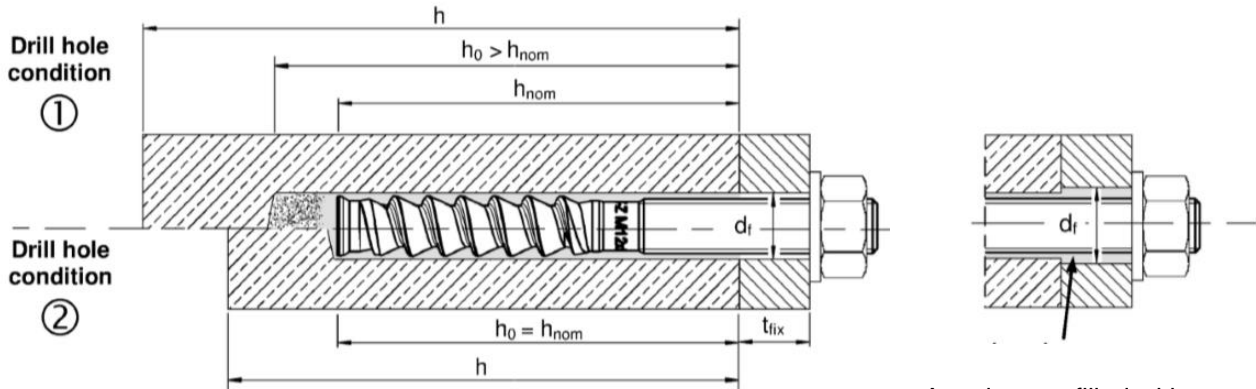

Drill hole condition 1 → non-cleaned borehole
 Drill hole condition 2 → drilling dust is completely removed

Annular gap filled with Hilti HIT-HY 200-A

Anchor dimension for HIT-Z

Anchor size		M8	M10	M12	M16	M20
Length of anchor	min l	80	95	105	155	215
	max l	120	160	196	420	450
Helix length	l_{Helix}	30 or 50	50 or 60	60	96	100

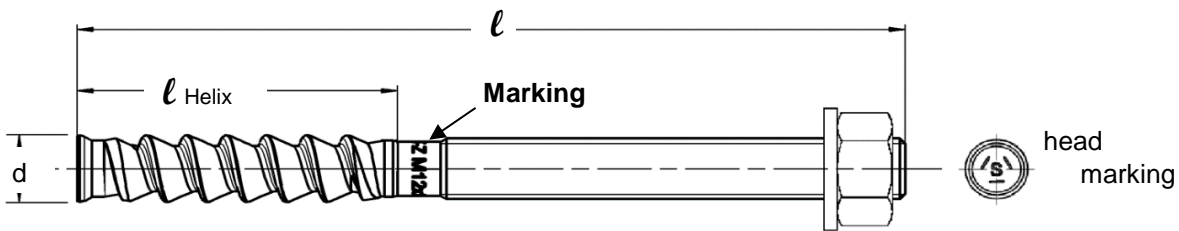

Minimum edge distance and spacing for HIT-Z

For the calculation of minimum spacing and minimum edge distance of anchors in combination with different embedment depth and thickness of concrete member the following equation shall be fulfilled: $A_{i,\text{req}} < A_{i,\text{cal}}$

Required interaction area $A_{i,\text{cal}}$ for HIT-Z

Anchor size		M8	M10	M12	M16	M20
Cracked concrete	[mm ²]	19200	40800	58800	94700	148000
Non-cracked concrete	[mm ²]	22200	57400	80800	128000	198000

Effective area $A_{i,\text{ef}}$ of HIT-Z

Member thickness $h \geq h_{\text{nom}} + 1,5 \cdot c$

Single anchor and group of anchors with $s > 3 \cdot c$	[mm ²]	$A_{i,\text{cal}} = (6 \cdot c) \cdot (h_{\text{nom}} + 1,5 \cdot c)$	with $c \geq 5 \cdot d$
Group of anchors with $s \leq 3 \cdot c$	[mm ²]	$A_{i,\text{cal}} = (3 \cdot c + s) \cdot (h_{\text{nom}} + 1,5 \cdot c)$	with $c \geq 5 \cdot d$ and $s \geq 5 \cdot d$

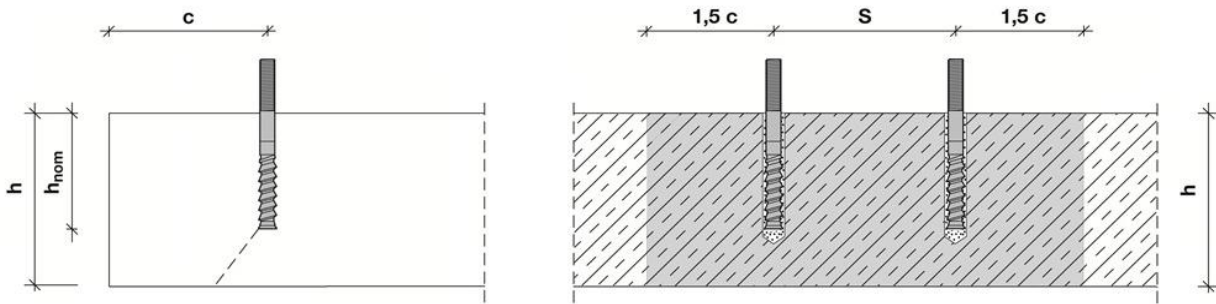
Member thickness $h \leq h_{nom} + 1,5 \cdot c$

Single anchor and group of anchors with $s >$	[mm ²]	$A_{i,cal} = (6 \cdot c) \cdot h$	with $c \geq 5 \cdot d$
Group of anchors with $s \leq 3 \cdot c$	[mm ²]	$A_{i,cal} = (3 \cdot c + s) \cdot h$	with $c \geq 5 \cdot d$ and $s \geq 5 \cdot d$

Best case minimum edge distance and spacing with required member thickness and embedment depth

Anchor size		M8	M10	M12	M16	M20
Cracked concrete						
Member thickness	$h \geq$ [mm]	140	200	240	300	370
Embedment depth	$h_{nom} \geq$ [mm]	80	120	150	200	220
Minimum spacing	s_{min} [mm]	40	50	60	80	100
Corresponding edge distance	$c \geq$ [mm]	40	55	65	80	100
Minimum edge distance	$c_{min} =$ [mm]	40	50	60	80	100
Corresponding spacing	$s \geq$ [mm]	40	60	65	80	100
Non-cracked concrete						
Member thickness	$h \geq$ [mm]	140	230	270	340	410
Embedment depth	$h_{nom} \geq$ [mm]	80	120	150	200	220
Minimum spacing	s_{min} [mm]	40	50	60	80	100
Corresponding edge distance	$c \geq$ [mm]	40	70	80	100	130
Minimum edge distance	c_{min} [mm]	40	50	60	80	100
Corresponding spacing	$s \geq$ [mm]	40	145	160	160	235

Best case minimum member thickness and embedment depth with required minimum edge distance and spacing (borehole condition 1)

Anchor size		M8	M10	M12	M16	M20
Cracked concrete						
Member thickness	$h \geq$ [mm]	120	120	120	196	200
Embedment depth	$h_{nom} \geq$ [mm]	60	60	60	96	100
Minimum spacing	s_{min} [mm]	40	50	60	80	100
Corresponding edge distance	$c \geq$ [mm]	40	100	140	135	215
Minimum edge distance	$c_{min} =$ [mm]	40	60	90	80	125
Corresponding spacing	$s \geq$ [mm]	40	160	220	235	365
Non cracked concrete						
Member thickness	$h \geq$ [mm]	120	120	120	196	200
Embedment depth	$h_{nom} \geq$ [mm]	60	60	60	96	100
Minimum spacing	s_{min} [mm]	40	50	60	80	100
Corresponding edge distance	$c \geq$ [mm]	50	145	200	190	300
Minimum edge distance	c_{min} [mm]	40	80	115	110	165
Corresponding spacing	$s \geq$ [mm]	65	240	330	310	495

Minimum edge distance and spacing – Explanation

Minimum edge and spacing geometrical requirements are determined by testing the installation conditions in which two anchors with a given spacing can be set close to an edge without forming a crack in the concrete due to tightening torque.

The HIT-Z boundary conditions for edge and spacing geometry can be found in the tables to the left. If the embedment depth and slab thickness are equal to or greater than the values in the table, then the edge and spacing values may be utilized.

PROFIS Anchor software is programmed to calculate the referenced equations in order to determine the optimized related minimum edge and spacing based on the following variables:

Cracked or non-cracked concrete	For cracked concrete it is assumed that a reinforcement is present which limits the crack width to 0,3 mm, allowing smaller values for minimum edge distance and minimum spacing
Anchor diameter	For smaller anchor diameter a smaller installation torque is required, allowing smaller values for minimum edge distance and minimum spacing
Slab thickness and embedment depth	Increasing these values allows smaller values for minimum edge distance and minimum spacing

Installation equipment

Anchor size	M8	M10	M12	M16	M20	M24	M27	M30
Rotary hammer	HAS-U	TE 2 – TE 16			TE 40 - TE 80			
	HIT-Z	TE 2 – TE 40		TE 40 – TE 80		-		
	HIS-N	TE (-A) – TE 16(-A)		TE 40 – TE 80		-		
Other tools	compressed air gun and blow out pump, set of cleaning brushes, dispenser Hollow Drill Bit							
	roughening tools TE-YRT							
Additional Hilti recommended tools	DD EC-1, DD 100 ... DD 160 ^{a)}							

a) For anchors in diamond drilled holes load values for combined pull-out and concrete cone resistance have to be reduced.



Cleaning, drilling and installation parameters

HAS-U	HIT-Z, HIT-Z-D ^{b)}	HAS-D	HIS-N	Drill bit diameters d ₀ [mm]				Cleaning and installation	
				Hammer drill (HD)	Hollow Drill Bit (HDB)	Diamond coring		Brush HIT-RB	Piston plug HIT-SZ
						Diamond coring (DD)	With roughening tool (RT)		
M8	M8	-	-	10	-	10	-	10	-
M10	M10	-	-	12	12	12	-	12	12
M12	M12	M12	M8	14	14	14	-	14	14
M16	M16	M16	M10	18	18	18	18	18	18
M20	M20	M20	M12	22 / 24 ^{a)}	22 / 24 ^{a)}	22 / 24 ^{a)}	22	22 / 24 ^{a)}	22 / 24 ^{a)}
M24	-	-	M16	28	28	28	28	28	28
M27	-	-	-	30	-	30	30	30	30
-	-	-	M20	32	32	32	32	32	32
M30	-	-	-	35	35	35	35	35	35

a) Only for HAS-D.

b) HIT-Z-D only available for M16.

Associated components for the use of Hilti Roughening tool TE-YRT

Diamond coring		Roughening tool TE-YRT	Wear gauge RTG...
			
d ₀ [mm]		d ₀ [mm]	size
Nominal	measured		
18	17,9 to 18,2	18	18
20	19,9 to 20,2	20	20
22	21,9 to 22,2	22	22
25	24,9 to 25,2	25	25
28	27,9 to 28,2	28	28
30	29,9 to 30,2	30	30
32	31,9 to 32,2	32	32
35	34,9 to 35,2	35	35

Installation parameters for use of the Hilti Roughening tool TE-YRT

h _{ef} [mm]	Minimum roughening time t _{roughen} [sec] (t _{roughen} [sec] = h _{ef} [mm] / 10)	Minimum blowing time t _{blowing} [sec] (t _{blowing} [sec] = t _{roughen} [sec] + 20)
0 to 100	10	30
101 to 200	20	40
201 to 300	30	50
301 to 400	40	60
401 to 500	50	70
501 to 600	60	80

Setting instructions for HAS-U rods and HIS-N internally threaded sleeves

*For detailed information on installation see instruction for use given with the package of the product



Safety regulations.

Review the Material Safety Data Sheet (MSDS) before use for proper and safe handling! Wear well-fitting protective goggles and protective gloves when working with Hilti HIT-HY 200 A (R).

Drilling

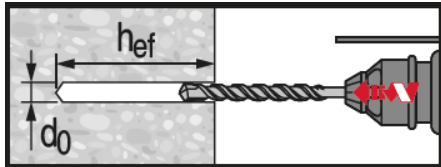

Hammer drilled hole (HD)

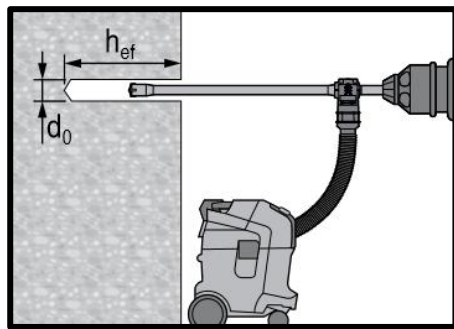

Hammer drilled hole with Hollow Drilled Bit (HDB)

No cleaning required

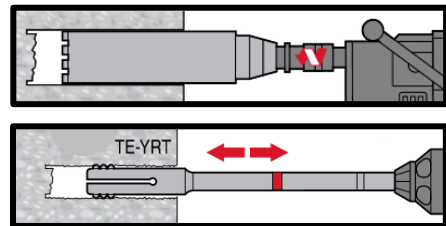

Diamond Drilling + Roughening Tool (DD+RT)

Cleaning

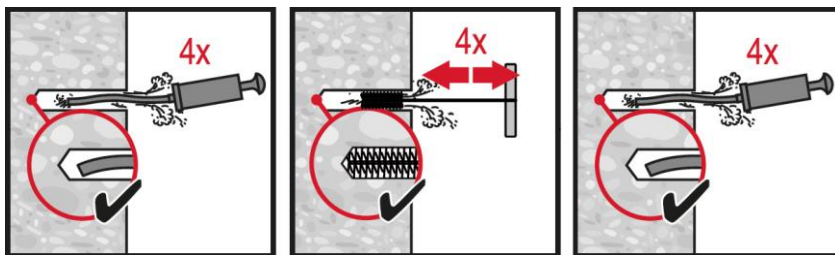

Hammer drilling:

Manual cleaning (MC)

for drill diameters $d_0 \leq 20$ mm and drill hole depth $h_0 \leq 10 \cdot d$.

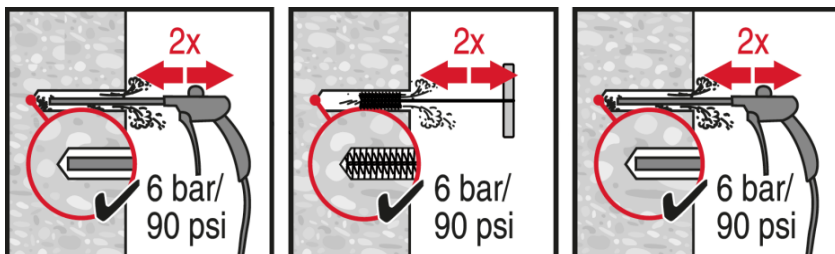

Hammer drilling:

Compressed air cleaning (CAC)

for all drill hole diameters d_0 and drill hole depths $h_0 \leq 20 \cdot d$.

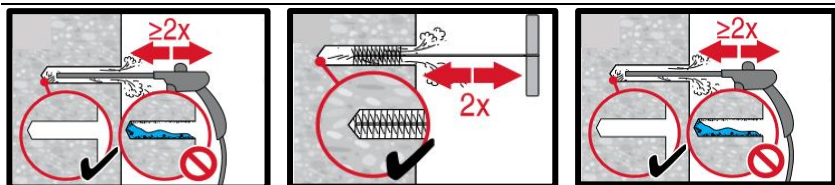

Diamond cored holes with Hilti roughening tool:

Compressed air cleaning (CAC)

for all drill hole diameters d_0 and drill hole depths h_0 .

Injection

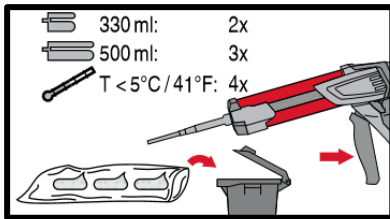
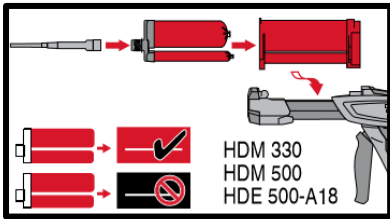

Injection system preparation.

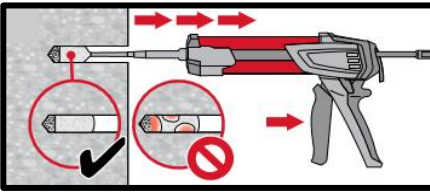
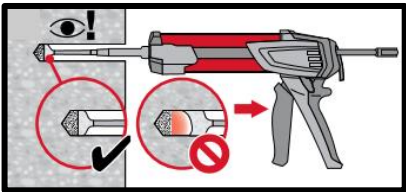

Injection method for drill hole depth $h_{ef} \leq 250$ mm.

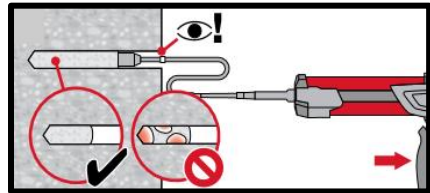
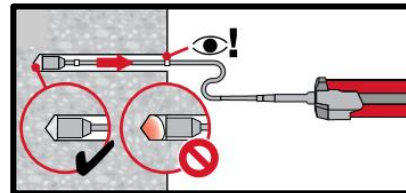

Injection method for drill hole depth $h_{ef} > 250$ mm.

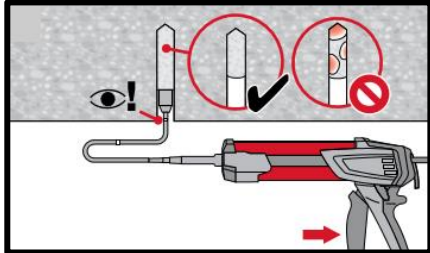
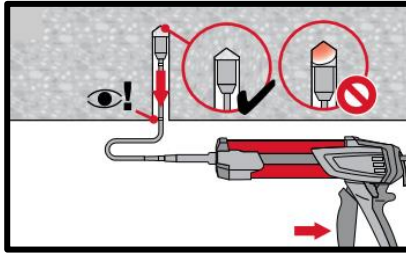

Injection method for overhead application and/or installation with embedment depth > 250 mm.

Setting the element

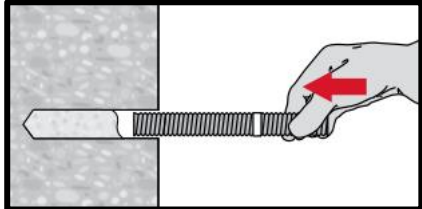

Setting element, observe working time " t_{work} ".

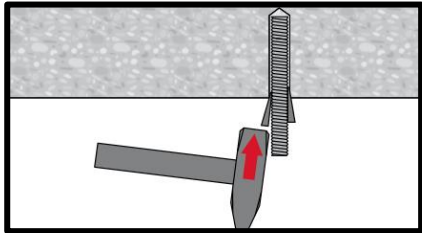

Setting element for overhead applications, observe working time " t_{work} ".

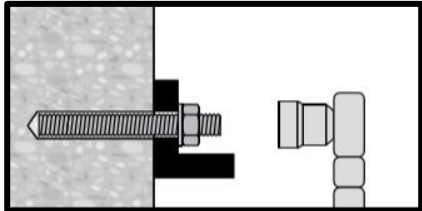

Loading the anchor after required curing time t_{cure}

Setting instructions for HIT-Z & HIT-Z(-D) rods

*For detailed information on installation see instruction for use given with the package of the product.



Safety regulations.

Review the Material Safety Data Sheet (MSDS) before use for proper and safe handling! Wear well-fitting protective goggles and protective gloves when working with Hilti HIT-HY 200 A (R)

Drilling

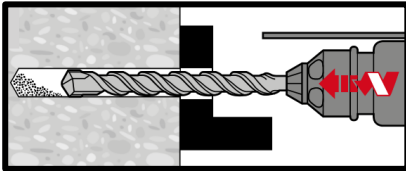

Hammer drilling: Through-setting

No cleaning required

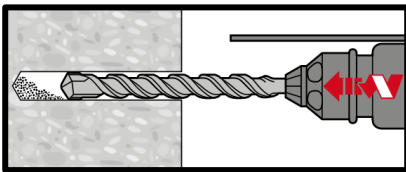

Hammer drilling: Pre-setting

No cleaning required

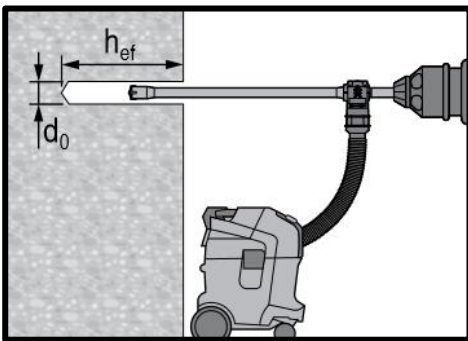

Hammer drilling with hollow drill bit: Through / pre-setting

No cleaning required

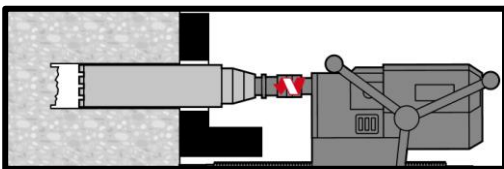

Diamond coring: Through-setting

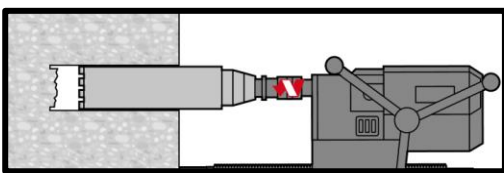

Diamond coring: Pre-setting

Cleaning

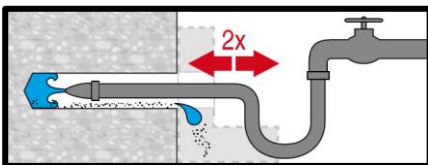

Hole flushing required for wet-drilled diamond cored holes.

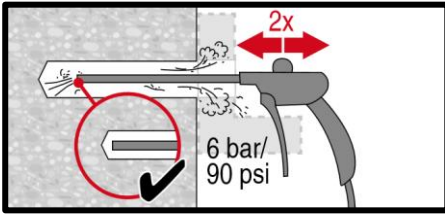

Evacuation required for wet-drilled diamond cored holes.

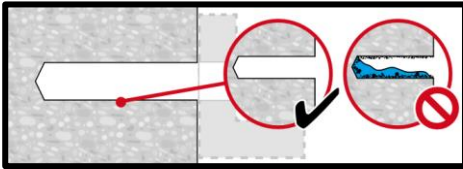

Injection

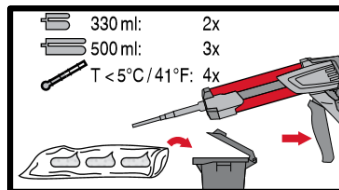
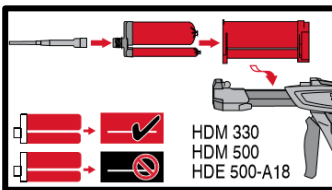

Injection system preparation.

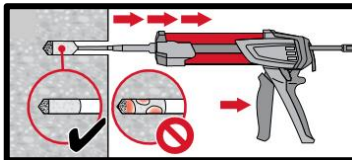
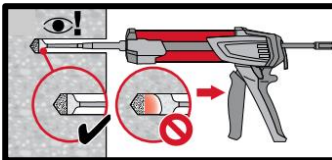

Injection of adhesive from the back of the drill hole without forming air voids.

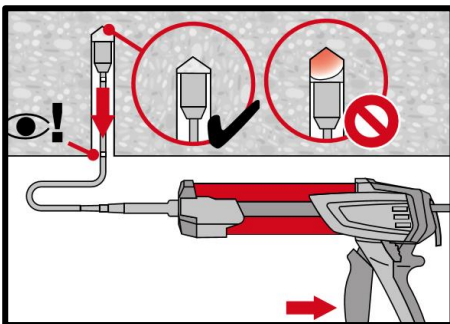

Overhead installation only with the aid of extensions and piston plugs.

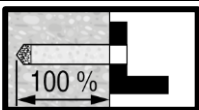

Through-setting:

Fill 100% of the drill hole.



Pre-setting:

Fill approx. 2/3 of the drill hole.

Setting the element

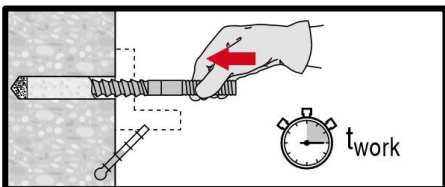

Setting element to the required embedment depth before working time "t_{work}" has elapsed.

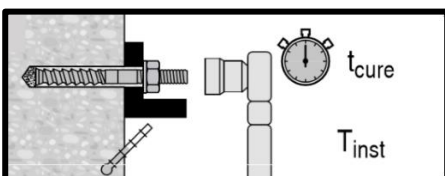

Loading the anchor: After required curing time t_{cure}.

Setting instructions for HAS-D rods

*For detailed information on installation see instruction for use given with the package of the product.



Safety regulations.

Review the Material Safety Data Sheet (MSDS) before use for proper and safe handling! Wear well-fitting protective goggles and protective gloves when working with Hilti HIT-HY 200 A (R)

Drilling

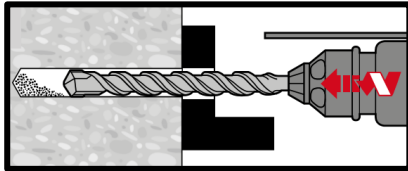

Hammer drilling: Through-setting

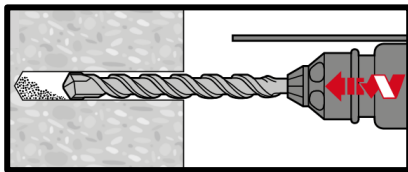

Hammer drilling: Pre-setting

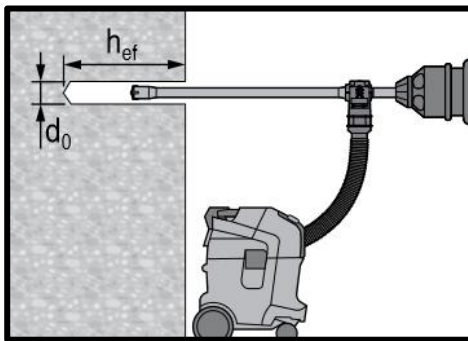

Hammer drilling with hollow drill bit: Through / pre-setting
No cleaning required

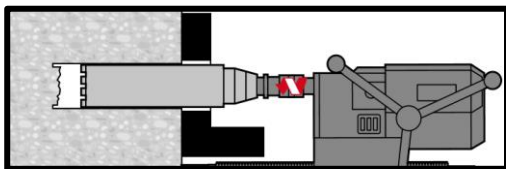

Diamond coring: Through-setting

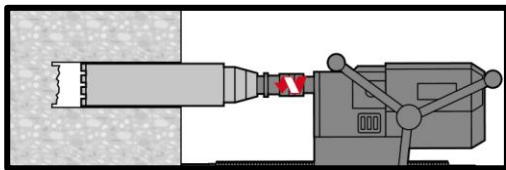

Diamond coring: Pre-setting

Cleaning

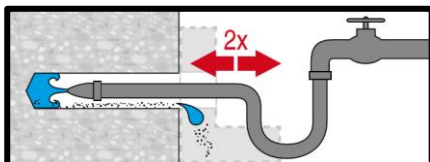

Hole flushing required for wet-drilled diamond cored holes.

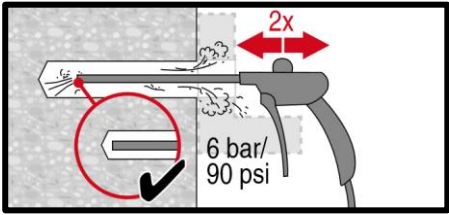

Evacuation required for wet-drilled diamond cored holes.

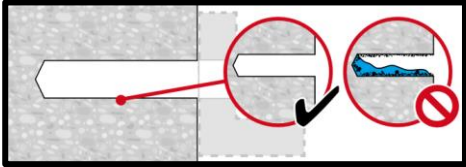

Injection

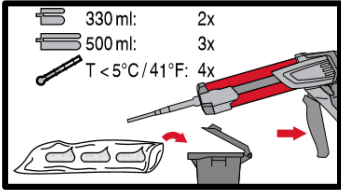
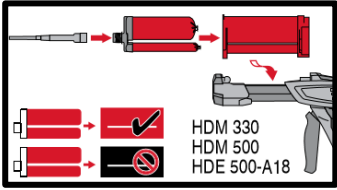

Injection system preparation.

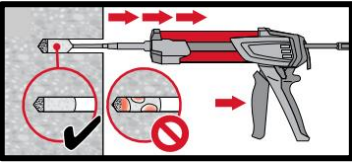
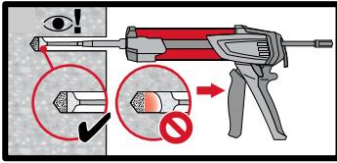

Injection of adhesive from the back of the drill hole without forming air voids.

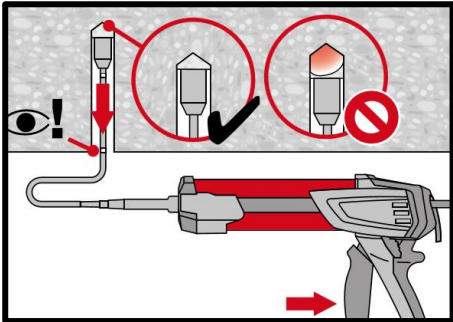

Overhead installation only with the aid of extensions and piston plugs.

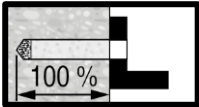

Through-setting:
Fill 100% of the drill hole.

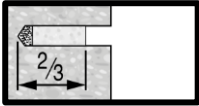

Pre-setting:
Fill approx. 2/3 of the drill hole.

Setting the element

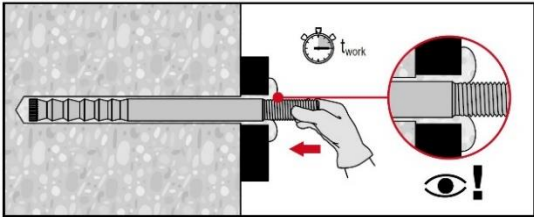

Setting element to the required embedment depth before working time "t_{work}" has elapsed.

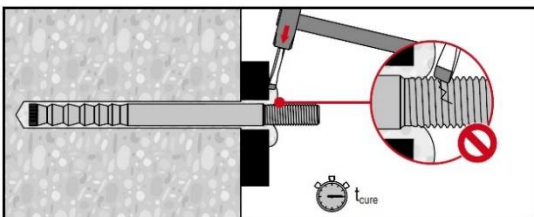

Removing excess mortar: After required curing time t_{cure}.

Final assembly with sealing washer

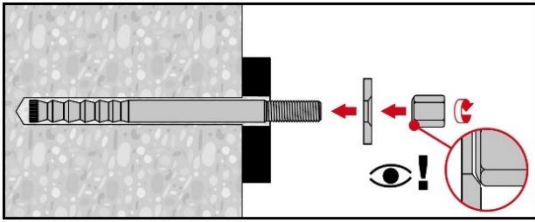

Installation: Orient the round part of the calotte nut to the sealing washer and install.

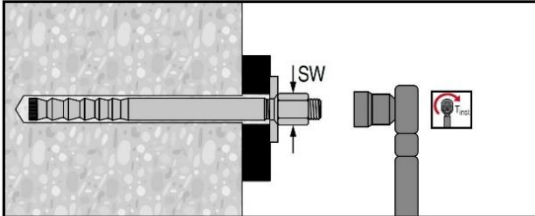

Installation torque moment

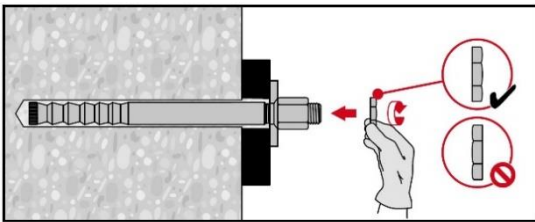



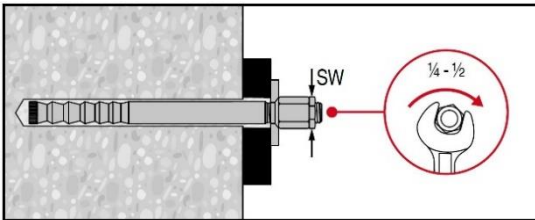











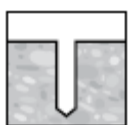

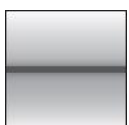
Applying the lock nut: Tighten with a $\frac{1}{4}$ to $\frac{1}{2}$ turn.

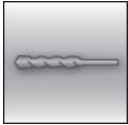

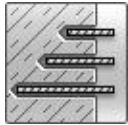
HIT-HY 200 injection mortar

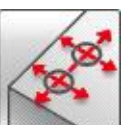
Anchor design (EN 1992-4) / Rebar elements / Concrete

Injection mortar system		Benefits
	<p>Hilti HIT - HY 200-A</p> <p>330 ml foil pack (also available as 500 ml foil pack)</p>	<ul style="list-style-type: none"> - SafeSet technology: Simplified method of borehole preparation using either Hilti hollow drill bit for hammer drilling or Roughening tool for diamond cored applications - ETA seismic approval C1 - Suitable for cracked and non-cracked concrete C 20/25 to C 50/60 - Suitable for dry and water saturated concrete - High loading capacity, excellent handling - Small edge distance and anchor spacing possible - In service temperature range up to 120°C short term / 72°C long term - Large diameter applications - Two mortar versions: HY 200-R for slow cure applications and HY 200-A for fast cure applications
	<p>Hilti HIT - HY 200-R</p> <p>330 ml foil pack (also available as 500 ml foil pack)</p>	
	<p>Rebar B500 B ($\phi 8$ - $\phi 32$)</p>	

Base material			Load conditions				
							
Concrete (non-cracked)	Concrete (cracked)	Dry concrete	Wet concrete	Static/ quasi-static	Seismic, ETA-C1	Fire resistance	
Installation conditions			Other informations				
							
Hammer drilling	Diamond drilled holes ^{a)}	Variable embedment depth	Hilti SafeSet technology	Small edge distance and spacing	European Technical Assessment	CE conformity	PROFIS Rebar design Software
<p>a) Diamond drilling only with Roughening Tool (RT).</p>							

Approvals / certificates

Description	Product	Authority / Laboratory	No. / date of issue
European Technical Assessment ^{a)}	HY 200-A (Anchor)	DIBt, Berlin	ETA-11/0493 / 2019-08-30
European Technical Assessment ^{a)}	HY 200-R (Anchor)	DIBt, Berlin	ETA-12/0084 / 2019-08-28

a) All data given in this section according to ETA-11/0493 issue 2019-08-30 and to ETA-12/0084 issue 2019-08-28.

Static and quasi-static loading (for a single anchor)

All data in this section applies to

- Correct setting (See setting instruction)
- No edge distance and spacing influence
- Steel failure
- Base material thickness, as specified in the table
- One typical embedment depth, as specified in the table
- One anchor material, as specified in the tables
- Concrete C 20/25
- Temperature range I
(min. base material temperature -40°C, max. long term/short term base material temperature: +24°C/40°C)
- Short term loading. For long term loading please apply $\psi_{\text{sus}} = 0.74$

Embedment depth and base material thickness for static and quasi-static loading data

Anchor- size	φ8	φ10	φ12	φ14	φ16	φ20	φ25	φ26	φ28	φ30	φ32
Typical embedment depth [mm]	80	90	110	125	125	170	210	240	270	270	300
Base material thickness [mm]	110	120	145	165	165	220	275	305	340	345	380

Characteristic resistance

Anchor- size	φ8	φ10	φ12	φ14	φ16	φ20	φ25	φ26	φ28	φ30	φ32
Non-cracked concrete											
Tensile N_{Rk}	24,1	33,9	49,8	66,0	68,7	109	150	183	218	218	256
Shear V_{Rk}	14,0	22,0	31,0	42,0	55,0	86,0	135	146	169	194	221
Cracked concrete											
Tensile N_{Rk}	-	14,1	29,0	38,5	44,0	74,8	105	128	153	153	179
Shear V_{Rk}	-	22,0	31,0	42,0	55,0	86,0	135	146	169	194	221

Design resistance

Anchor- size	φ8	φ10	φ12	φ14	φ16	φ20	φ25	φ26	φ28	φ30	φ32
Non-cracked concrete											
Tensile N_{Rd}	16,1	22,6	33,2	44,0	45,8	72,7	99,8	122	146	146	170
Shear V_{Rd}	9,3	14,7	20,7	28,0	36,7	57,3	90,0	97,3	113	129	147
Cracked concrete											
Tensile N_{Rd}	-	9,4	19,4	25,7	29,3	49,8	69,9	85,4	102	102	119
Shear V_{Rd}	-	14,7	20,7	28,0	36,7	57,3	90,0	97,3	113	129	147

Seismic loading (for a single anchor)

All data in this section applies to:

- Correct setting (See setting)
- No edge distance and spacing influence
- Steel failure
- Minimum base material thickness
- Concrete C 20/25
- Temperature range I
(min, base material temperature -40°C, max, long term/short term base material temperature: +24°C/40°C)
- $\alpha_{\text{gap}} = 1,0$

Embedment depth and base material thickness in case of seismic performance category C1

Anchor- size	$\phi 8$	$\phi 10$	$\phi 12$	$\phi 14$	$\phi 16$	$\phi 20$	$\phi 25$	$\phi 26$	$\phi 28$	$\phi 30$	$\phi 32$
Typical embedment depth [mm]	-	90	110	125	125	170	210	240	270	270	300
Base material thickness [mm]	-	120	145	165	165	220	275	305	340	345	380

Characteristic resistance in case of seismic performance category C1

Anchor- size	$\phi 8$	$\phi 10$	$\phi 12$	$\phi 14$	$\phi 16$	$\phi 20$	$\phi 25$	$\phi 26$	$\phi 28$	$\phi 30$	$\phi 32$
Tensile $N_{Rk, \text{seis}}$	-	12,4	25,3	33,5	38,3	65,2	99,6	120	145	145	170
Shear $V_{Rk, \text{seis}}$	-	15,0	22,0	29,0	39,0	60,0	95,0	102	118	136	155

Design resistance in case of seismic performance category C1

Anchor- size	$\phi 8$	$\phi 10$	$\phi 12$	$\phi 14$	$\phi 16$	$\phi 20$	$\phi 25$	$\phi 26$	$\phi 28$	$\phi 30$	$\phi 32$
Tensile $N_{Rd, \text{seis}}$	-	8,3	16,9	22,4	25,6	43,4	66,4	79,7	96,6	96,8	113
Shear $V_{Rd, \text{seis}}$	-	10,0	14,7	19,3	26,0	40,0	63,3	68,0	78,7	90,7	103

Materials

Mechanical properties

Anchor size	$\phi 8$	$\phi 10$	$\phi 12$	$\phi 14$	$\phi 16$	$\phi 20$	$\phi 25$	$\phi 26$	$\phi 28$	$\phi 30$	$\phi 32$
Nominal tensile strength f_{uk} [N/mm ²]	550	550	550	550	550	550	550	550	550	550	550
Yield strength f_{yk} [N/mm ²]	500	500	500	500	500	500	500	500	500	500	500
Stressed cross-section A_s [mm ²]	50,3	78,5	113	154	201	314	491	531	616	707	804
Moment of resistance W [mm ³]	50,3	98,2	170	269	402	785	1534	1726	2155	2651	3217

Material quality

Part	Material
Rebar EN 1992-1-1:2004 and AC:2010	Bars and de-coiled rods class B or C according to NDP or NCL of EN 1992-1-1/NA:2013

Setting information

Installation temperature range

- 10°C to + 40°C

Service temperature range

Hilti HIT-HY 200 injection mortar may be applied in the temperature ranges given below, An elevated base material temperature may lead to a reduction of the design bond resistance,

Temperature range	Base material temperature	Max, long term base material temperature	Max, short term base material temperature
Temperature range I	-40 °C to + 40 °C	+ 24 °C	+ 40 °C
Temperature range II	-40 °C to + 80 °C	+ 50 °C	+ 80 °C
Temperature range III	-40 °C to + 120 °C	+ 72 °C	+ 120 °C

Max, short term base material temperature

Short term elevated base material temperatures are those that occur over brief intervals, e.g, as a result of diurnal cycling,

Max, long term base material temperature

Long term elevated base material temperatures are roughly constant over significant periods of time,

Curing and working time

Temperature of the base material	HIT-HY 200-A		HIT-HY 200-R	
	Maximum working time t_{work}	Minimum curing time t_{cure}	Maximum working time t_{work}	minimum curing time t_{cure}
- 10°C < T_{BM} ≤ - 5°C	1,5 h	7 h	3 h	20 h
- 5°C < T_{BM} ≤ 0°C	50 min	4 h	2 h	8 h
0°C < T_{BM} ≤ 5°C	25 min	2 hour	1 h	4 h
5°C < T_{BM} ≤ 10°C	15 min	75 min	40 min	2,5 h
10°C < T_{BM} ≤ 20°C	7 min	45 min	15 min	1,5 h
20°C < T_{BM} ≤ 30°C	4 min	30 min	9 min	1 h
30°C < T_{BM} ≤ 40°C	3 min	30 min	6 min	1 h

Installation equipment

Anchor size	φ8	φ10	φ12	φ14	φ16	φ20	φ25	φ26	φ28	φ30	φ32
Rotary hammer	TE 2 (-A) – TE 16 (-A)					TE 40 – TE 80					
Other tools	Compressed air gun, blow out pump Set of cleaning brushes, dispenser										

Setting details / Design parameters

Anchor size	Ø8	Ø10	Ø12	Ø14	Ø16	Ø20	Ø25	Ø26	Ø28	Ø30	Ø32	
Nominal diameter of drill bit d_0 [mm]	10 / 12 ^{a)}	12 / 14 ^{a)}	14 / 16 ^{a)}	18	20	25	32	32	35	37	40	
Effective anchorage and drill hole depth range ^{b)}	$h_{ef,min}$ [mm]	60	60	70	75	80	90	100	104	112	120	128
	$h_{ef,max}$ [mm]	160	200	240	280	320	400	500	520	560	600	640
Minimum base material thickness h_{min} [mm]	$h_{ef} + 30 \text{ mm} \geq 100 \text{ mm}$			$h_{ef} + 2 d_0$								
Minimum spacing s_{min} [mm]	40	50	60	70	80	100	125	130	140	150	160	
Minimum edge distance c_{min} [mm]	40	45	45	50	50	65	70	75	75	80	80	
Critical spacing for splitting failure $s_{cr,sp}$ [mm]	$2 c_{cr,sp}$											
Critical edge distance for splitting failure ^{c)} $c_{cr,sp}$ [mm]	$1,0 \cdot h_{ef}$						for $h / h_{ef} \geq 2,0$					
	$4,6 h_{ef} - 1,8 h$						for $2,0 > h / h_{ef} > 1,3$					
	$2,26 h_{ef}$						for $h / h_{ef} \leq 1,3$					
Critical spacing for concrete cone failure $s_{cr,N}$ [mm]	$2 c_{cr,N}$											
Critical edge distance for concrete cone failure $c_{cr,N}$ [mm]	$1,5 h_{ef}$											

For spacing (edge distance) smaller than critical spacing (critical edge distance) the design loads have to be reduced,

- a) Both given values for drill bit diameter can be used.
- b) $h_{ef,min} \leq h_{ef} \leq h_{ef,max}$ (h_{ef} : embedment depth).
- c) h : base material thickness ($h \geq h_{min}$).

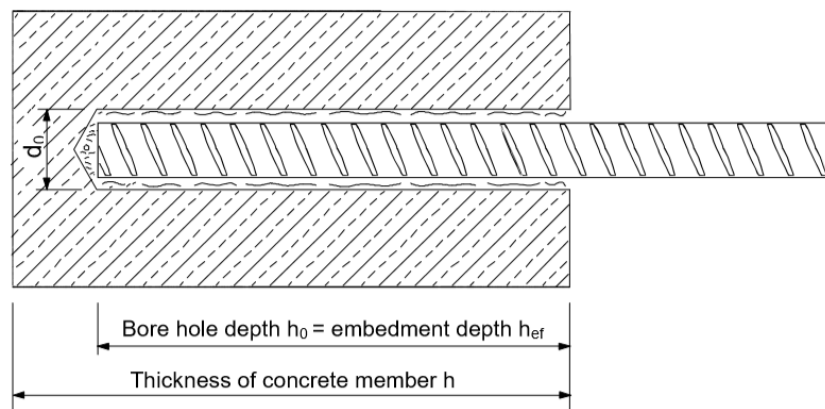
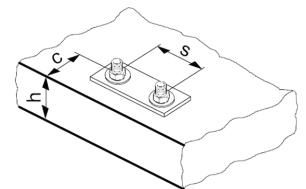

Drilling and cleaning diameters

Rebar	Hammer drill (HD)	Hollow Drill Bit (HDB)	Diamond coring with Roughening Tool (RT)	Brush HIT-RB
d ₀ [mm]				size [mm]
φ8	12 / 10 ^{a)}	12	-	12 / 10 ^{a)}
φ10	14 / 12 ^{a)}	14 / 12 ^{a)}	-	14 / 12 ^{a)}
φ12	16 / 14 ^{a)}	16 / 14 ^{a)}	-	16 / 14 ^{a)}
φ14	18	18	18	18
φ16	20	20	20	20
φ20	25	25	25	25
φ25	32	32	32	32
φ26	32	32	35	32
φ28	35	35	35	35
φ30	37	-	-	37
φ32	40	-	-	40

a) Both given values can be used.

Associated components for the use of Hilti Roughening tool TE-YRT

Diamond coring		Roughening tool TE-YRT	Wear gauge RTG...
d ₀ [mm]		d ₀ [mm]	size
Nominal	measured		
18	17,9 to 18,2	18	18
20	19,9 to 20,2	20	20
22	21,9 to 22,2	22	22
25	24,9 to 25,2	25	25
28	27,9 to 28,2	28	28
30	29,9 to 30,2	30	30
32	31,9 to 32,2	32	32
35	34,9 to 35,2	35	35

Installation parameters for use of the Hilti Roughening tool TE-YRT

h _{ef} [mm]	Minimum roughening time t _{roughen} [sec] (t _{roughen} [sec] = h _{ef} [mm] / 10)	Minimum blowing time t _{blowing} [sec] (t _{blowing} [sec] = t _{roughen} [sec] + 20)
0 to 100	10	30
101 to 200	20	40
201 to 300	30	50
301 to 400	40	60
401 to 500	50	70
501 to 600	60	80

Setting instructions

*For detailed information on installation see instruction for use given with the package of the product,



Safety regulations.

Review the Material Safety Data Sheet (MSDS) before use for proper and safe handling! Wear well-fitting protective goggles and protective gloves when working with Hilti HIT-HY 200.

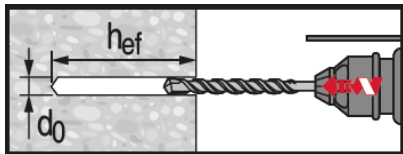

Hammer drilled hole (HD)

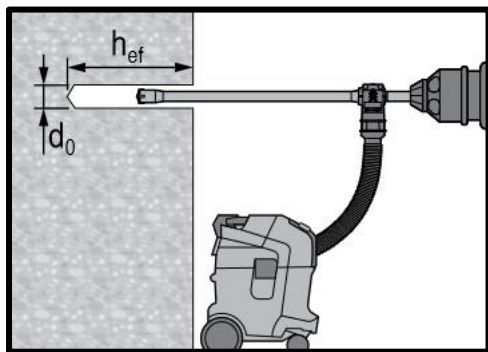

Hammer drilled hole with Hollow Drilled Bit (HDB)

No cleaning required

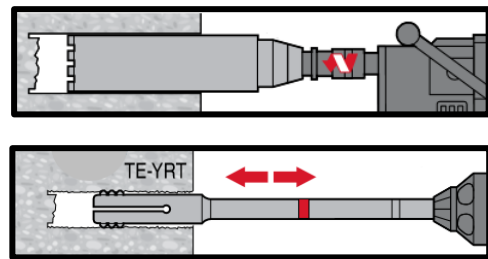

Diamond Drilling + Roughening Tool (DD+RT)

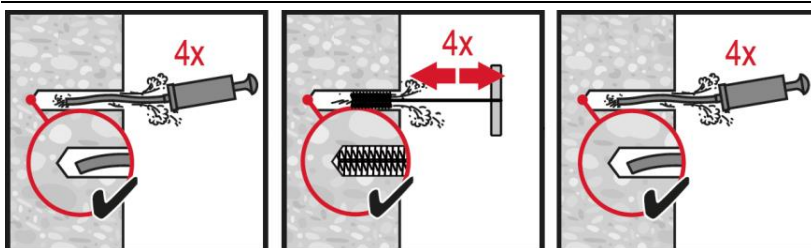

Hammer drilling:

Manual cleaning (MC)

for drill diameters $d_0 \leq 20$ mm and drill hole depth $h_0 \leq 10 \cdot d$.

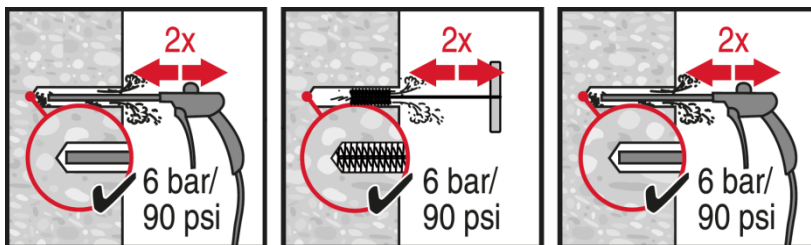

Hammer drilling:

Compressed air cleaning (CAC)

for all drill hole diameters d_0 and drill hole depths $h_0 \leq 20 \cdot d$.

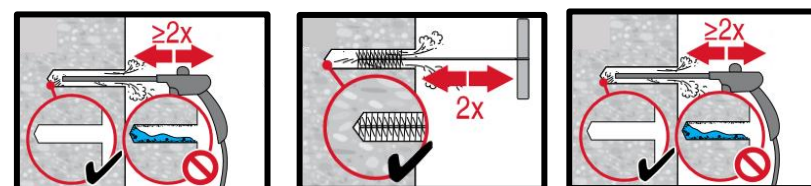

Diamond cored holes with Hilti roughening tool:

Compressed air cleaning (CAC)

for all drill hole diameters d_0 and drill hole depths h_0 .

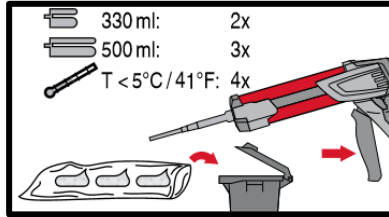
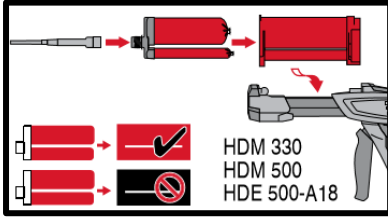

Injection system preparation.

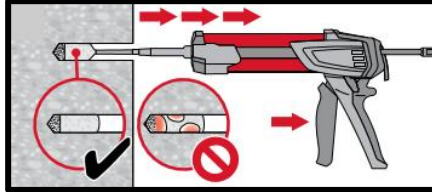
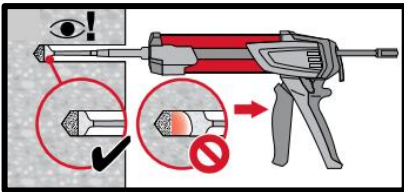

Injection method for drill hole depth
 $h_{ef} \leq 250 \text{ mm}$.

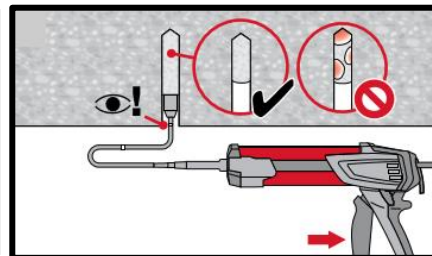
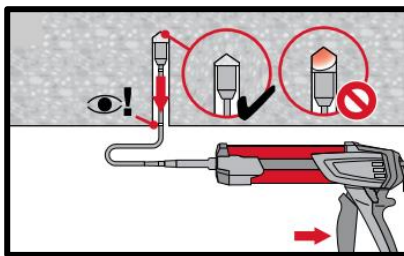

Injection method for overhead
application and/or installations with
embedment depth $h_{ef} \geq 250 \text{ mm}$.

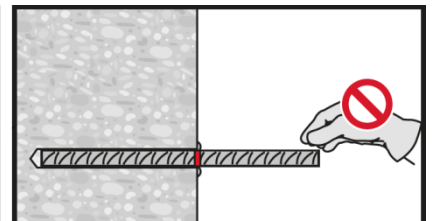
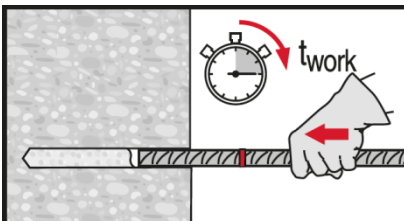

Setting element, observe working time
“ t_{work} ”.

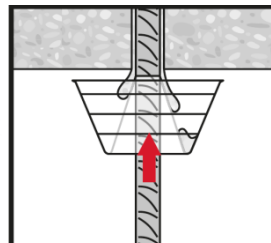
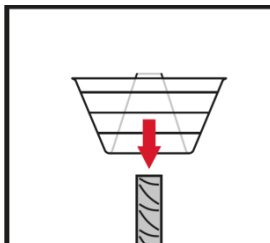
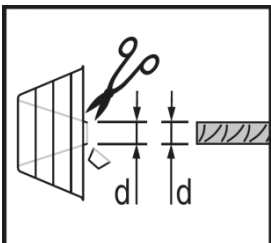

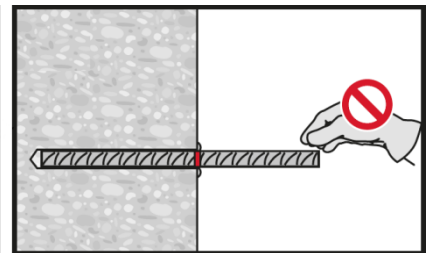
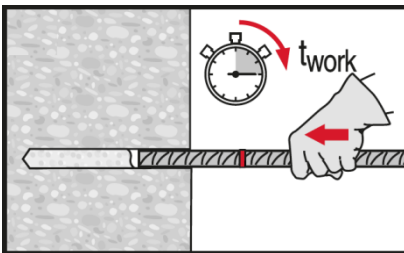

Setting element for overhead
applications, observe working time “ t_{work} ”.







Setting element, observe working time
“ t_{work} ”.

HIT-HY 200 injection mortar



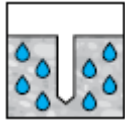
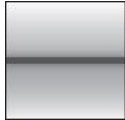

Rebar design (EN 1992-1-1) / Rebar elements / Concrete

Injection mortar system	Benefits
 <p>Hilti HIT-HY 200-R 330 ml foil pack (also available as 500 ml foil pack)</p>	<ul style="list-style-type: none"> - SafeSet technology: Simplified method of borehole preparation using either Hilti hollow drill bit for hammer drilling or Roughening tool for diamond cored applications - HY 200-R version is formulated for best handling and cure time specifically for rebar applications - Approved for ETA seismic C1 approval for post-installed-rebar - Suitable for concrete C 12/15 to C 50/60 - Suitable for dry and water saturated concrete - For rebar diameters up to 32 mm - Non corrosive to rebar elements - Good load capacity at elevated temperatures - Suitable for embedment length up to 1000 mm - Suitable for applications down to -10 °C - Two mortar versions: HY 200-A for slow cure applications and HY 200-R for fast cure applications
 <p>Hilti HIT-HY 200-A 330 ml foil pack (also available as 500 ml foil pack)</p>	
 <p>Rebar (ϕ8 - ϕ32)</p>	

Base material Load conditions

						
Concrete (non-cracked)	Concrete (cracked)	Dry concrete	Wet concrete	Static/ quasi-static	Seismic, CSTB ^{a)} /ETA-C1 ^{b)}	Fire resistance

Installation conditions Other informations

					
Hammer drilling	Diamond drilled holes ^{c)}	Hilti SafeSet technology	European Technical Assessment	CE conformity	PROFIS Rebar design Software

a) Seismic data only valid for HY 200-A.
 b) Seismic data only valid for HY 200-R.
 c) Diamond drilling only with Roughening Tool (RT).

Approvals / certificates

Description	Product	Authority / Laboratory	No. / date of issue
European Technical Assessment ^{a)}	HY 200-A (Rebar)	DIBt, Berlin	ETA-11/0492 / 2014-06-26
European Technical Assessment ^{a)}	HY 200-R (Rebar)	DIBt, Berlin	ETA-12/0083 / 2019-06-21
Assessment (fire)	HY 200-A	CSTB, Marne la Vallée	Z-21.8-1948 / 2013-11-14
Assessment (fire)	HY 200-R	CSTB, Marne la Vallée	Z-21.8-1947 / 2014-07-22

a) All data given in this section according to ETA-11/0492, issue 2014-06-26 and ETA-12/0083, issue 2019-06-21.

Static and quasi-static loading

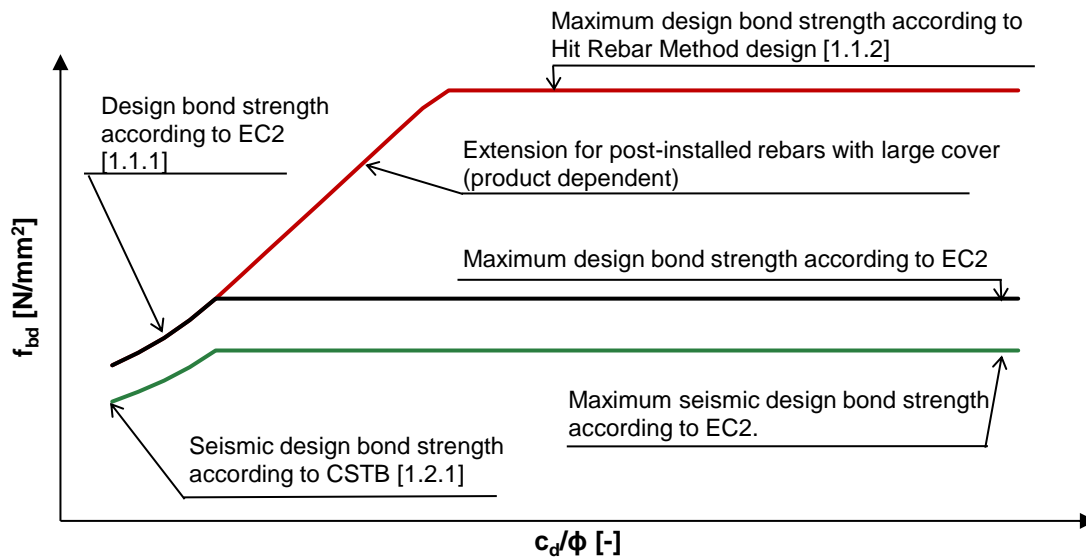

Effective limit on bond stress for post-installed rebar using Hilti mortar systems and design bond strength values as provided by the EC2.

Static EC2 design (small concrete cover)

Design bond strength in N/mm² for good bond conditions

All allowed drilling methods									
Rebar - size	Concrete class								
	C12/15	C16/20	C20/25	C25/30	C30/37	C35/45	C40/50	C45/55	C50/60
φ8 - φ32	1,6	2,0	2,3	2,7	3,0	3,4	3,7	4,0	4,3

For poor bond conditions multiply the values by 0,7. Values valid for non-cracked and cracked concrete.

Maximum design bond strength in N/mm² for good bond conditions

Non-cracked concrete, all allowed drilling methods								
Temperature range	Rebar - size	Concrete class						
		C20/25	C25/30	C30/37	C35/45	C40/45	C45/55	C50/60
I: 40°C/24°C	φ8 - φ32	8	8,2	8,3	8,4	8,6	8,7	8,8
II: 58°C/35°C		6,7	6,8	6,9	7,0	7,1	7,2	7,3
III: 70°C/43°C		5,7	5,8	5,9	6,0	6,1	6,1	6,2
Cracked concrete, all allowed drilling methods								
I: 40°C/24°C	φ12 - φ32	4,7	4,8	4,8	4,9	5,0	5,1	5,1
II: 58°C/35°C		3,7	3,7	3,8	3,9	3,9	4,0	4,0
III: 70°C/43°C		3,3	3,4	3,5	3,5	3,6	3,6	3,7

For poor bond conditions multiply the values by 0,7. *The reduction factor for rebar diameter equal to 10 mm is 0,72.

Additional Hilti Technical Data:

Reduction factor for splitting with large concrete cover: $\delta = 0,306$ (Hilti additional data)

Minimum anchorage length and minimum lap length

The minimum anchorage length $l_{b,min}$ and the minimum lap length $l_{0,min}$ according to EN 1992-1-1 shall be multiplied by relevant **Amplification factor α_{lb}** in the table below.

Amplification factor α_{lb} for the min. anchorage length and min. lap length for

All allowed hammer drilling methods									
Rebar - size	Concrete class								
	C12/15	C16/20	C20/25	C25/30	C30/37	C35/45	C40/50	C45/55	C50/60
$\phi 8 - \phi 32$	1,0								

Anchorage length for characteristic steel strength $f_{yk}=500 \text{ N/mm}^2$ for good conditions

All allowed drilling methods									
Rebar-size	Concrete class	Yielding load [kN]	$l_{b,min}^1$ [mm]	$l_{0,min}^1$ [mm]	$l_{bd,y}^2$ ($\alpha 2=1$) [mm]	$l_{bd,y}^3$ ($\alpha 2=0.7$) [mm]	$l_{bd,y,HRM}^4$ ($\alpha 2<0.7$) [mm]	l_{max}^5 $-10^\circ\text{C} \leq c_t \leq 0^\circ\text{C}$ [mm]	l_{max}^5 $c_t > 0^\circ\text{C}$ [mm]
$\phi 8$	C20/25	21,9	113	200	378	265	109	700	1000
$\phi 8$	C50/60	21,9	100	200	202	142	99	700	1000
$\phi 10$	C20/25	34,1	142	200	473	331	136	700	1000
$\phi 10$	C50/60	34,1	100	200	253	177	124	700	1000
$\phi 12$	C20/25	49,2	170	200	567	397	163	700	1000
$\phi 12$	C50/60	49,2	120	200	303	212	148	700	1000
$\phi 14$	C20/25	66,9	198	210	662	463	190	700	1000
$\phi 14$	C50/60	66,9	140	210	354	248	173	700	1000
$\phi 16$	C20/25	87,4	227	240	756	529	217	700	1000
$\phi 16$	C50/60	87,4	160	240	404	283	198	700	1000
$\phi 18$	C20/25	110,6	255	270	851	595	245	700	1000
$\phi 18$	C50/60	110,6	180	270	455	319	222	700	1000
$\phi 20$	C20/25	136,6	284	300	945	662	272	700	1000
$\phi 20$	C50/60	136,6	200	300	506	354	247	700	1000
$\phi 22$	C20/25	165,3	312	330	1040	728	299	700	1000
$\phi 22$	C50/60	165,3	220	330	556	389	272	700	1000
$\phi 24$	C20/25	196,7	340	360	1134	794	326	700	1000
$\phi 24$	C50/60	196,7	240	360	607	425	296	700	1000
$\phi 25$	C20/25	213,4	354	375	1181	827	340	700	1000
$\phi 25$	C50/60	213,4	250	375	632	442	309	700	1000
$\phi 26$	C20/25	230,8	369	390	1229	860	353	700	1000
$\phi 26$	C50/60	230,8	260	390	657	460	321	700	1000
$\phi 28$	C20/25	267,7	397	420	1323	926	380	700	1000
$\phi 28$	C50/60	267,7	280	420	708	495	346	700	1000
$\phi 30$	C20/25	307,3	425	450	1418	992	408	700	1000
$\phi 30$	C50/60	307,3	300	450	758	531	371	700	1000
$\phi 32$	C20/25	349,7	454	480	1512	1059	435	700	1000
$\phi 32$	C50/60	349,7	320	480	809	566	395	700	1000

1) According to EC2: EN 1992-1-1:2004 $l_{b,min}$ (8.6) and $l_{0,min}$ (8.11) are calculated for good bond conditions with characteristic yield strength $f_{yk} = 500 \text{ N/mm}^2$, $\gamma_M=1,15$ and $\alpha_6 = 1,0$.

2) Embedment depth for yield of the rebar and for $c_d/\phi = 1$ (characteristic yield strength $f_{yk} = 500 \text{ N/mm}^2$).

3) Embedment depth for yield of the rebar and for $c_d/\phi = 3$ (characteristic yield strength $f_{yk} = 500 \text{ N/mm}^2$).

4) Embedment depth according to Hit Rebar design for yield of the rebar and for $c_d/\phi > 8$ (Temperature range I, characteristic yield strength $f_{yk} = 500 \text{ N/mm}^2$).

5) c_t =concrete temperature.

Seismic data

Seismic data according to ETA-12/0083 assessment

Seismic reduction factor $k_{b,seis}$ for hammer drilling (HD) and (HDB) and compressed air drilling (CA)

Rebar - size	Reduction factor $k_{b,seis}$							
	Concrete class							
	C16/20	C20/25	C25/30	C30/37	C35/45	C40/50	C45/55	C50/60
$\phi 12 - \phi 18$	1,0				0,90	0,82	0,76	0,71
$\phi 20 - \phi 30$	1,0						0,92	0,86
$\phi 32$	1,0							

For poor bond conditions multiply the values 0,7.

Design values for the ultimate bond resistance $f_{bd,seis}$ ¹⁾ in N/mm² for seismic loading for hammer drilling (HD) and (HDB) and compressed air drilling (CA)

Rebar - size	Bond resistance $f_{bd,seis}$							
	Concrete class							
	C16/20	C20/25	C25/30	C30/37	C35/45	C40/50	C45/55	C50/60
$\phi 12 - \phi 18$	2,0	2,3	2,7	3,0				
$\phi 20 - \phi 30$	2,0	2,3	2,7	3,0	3,4	3,7		
$\phi 32$	2,0	2,3	2,7	3,0	3,4	3,7	4,0	4,3

1) According to EN 1992-1-1:2004 for good bond conditions. For all other bond conditions multiply the values by 0.7.

Fire resistance

a) Anchoring application

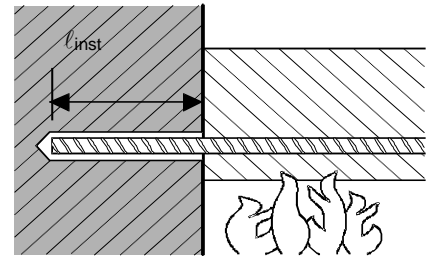

Maximum force ($F_{s,T,max}$) in rebar in conjunction with HIT-HY 200 as a function of embedding depth (l_{inst}) for the fire resistance classes F30 to F180 according to EC2.

Rebar-size	$F_{s,T,max}$ [kN]	l_{inst} [mm]	Fire resistance of bar [kN]				
			R30	R60	R90	R120	R180
$\phi 8$	16,19	80	3,0	0,7	0,2	0,0	0,0
		120	7,0	2,2	1,3	0,7	0,2
		170	16,2	10,2	9,2	4,0	1,7
		210		16,2	11,0	7,5	
		230			14,5	10,9	
		250			16,2	14,5	
		300			16,2	16,2	
$\phi 10$	25,29	100	6,1	2,0	1,0	0,4	0,0
		150	19,3	9,3	7,1	2,2	1,0
		190	25,3	18,0	15,9	9,3	4,9
		230		25,3	24,7	18,1	13,7
		260			24,7	20,3	
		280			25,3	24,7	
		320			25,3	25,3	
$\phi 12$	36,42	120	15,3	6,0	1,9	1,1	0,3
		180	31,0	19,0	17,8	8,5	7,0

Maximum force ($F_{s,T,max}$) in rebar in conjunction with HIT-HY 200 as a function of embedment depth (ℓ_{inst}) for the fire resistance classes F30 to F180 according to EC2

$\phi 12$	36,42	220	36,4	29,6	27,0	19,1	13,8		
		260		36,4	36,4	36,4	29,7	24,4	
		280					35,0	29,6	
		300					36,4	34,9	
		340						36,4	
$\phi 14$	49,58	140	24,0	9,9	6,9	2,6	1,0		
		210	45,0	31,4	28,5	25,7	13,0		
		240	49,6	40,6	37,7	32,8	22,3		
		280		49,6	49,6	49,6	40,7	34,6	
		300					44,7	40,7	
		330					49,6	48,1	
		360						49,6	
$\phi 16$	64,75	160					34,5	18,4	14,9
		240	62,6	46,4	43,0	37,7	25,5		
		260	64,8	53,5	50,0	44,7	32,5		
		300		64,8	64,8	64,8	57,0	49,6	
		330					61,3	57,2	
		360					64,8	62,7	
		400						64,8	
$\phi 20$	101,18	200					60,7	40,0	36,3
		250	78,3	62,5	58,3	51,3	36,3		
		310	101,2	88,9	84,6	77,6	62,6		
		350		101,2	101,2	101,2	94,2	80,2	
		370					83,5		
		390					97,8		
		430					101,2		
$\phi 25$	158,09	250					97,9	78,1	72,6
		280	126,5	94,6	89,4	81,2	61,8		
		370	158,1	144,0	127,9	119,7	111,2		
		410		158,1	158,1	158,1	150,0	141,8	123,2
		430					150,0	144,2	
		450					158,1	155,2	
		500					158,1		
$\phi 32$	158,09	250					97,9	78,1	72,6
		280	126,5	94,6	89,4	81,2	61,8		
		370	158,1	144,0	127,9	119,7	111,2		
		410		158,1	158,1	158,1	150,0	141,8	123,2
		430					150,0	144,2	
		450					158,1	155,2	
		500					158,1		

Characteristic yield strength $f_{yk} = 500 \text{ N/mm}^2$

Steel failure

b) Overlap joint application

Max. bond stress, $f_{bd, FIRE}$, depending on actual clear concrete cover for classifying the fire resistance.

It must be verified that the actual force in the bar during a fire, $F_{s, T}$, can be taken up by the bar connection of the selected length, l_{inst} . Note: Cold design for ULS is mandatory.

$$F_{s, T} \leq (l_{inst} - c_f) \cdot \phi \cdot \pi \cdot f_{bd, FIRE} \quad \text{where: } (l_{inst} - c_f) \geq l_s;$$

l_s = lap length

ϕ = nominal diameter of bar

$l_{inst} - c_f$ = selected overlap joint length; this must be at least l_s ,

but may not be assumed to be more than 80ϕ

$f_{bd, FIRE}$ = bond stress when exposed to fire

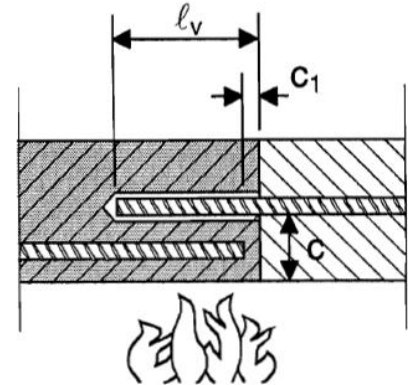

Critical temperature-dependent bond stress, τ_c , concerning “overlap joint” for Hilti HIT-HY 200 injection adhesive in relation to fire resistance class and required minimum concrete coverage c.

Clear concrete cover c [mm]	Max. bond stress, τ_c [N/mm ²]					
	R30	R60	R90	R120	R180	
30	0,6	0,3	-	-	-	
35	0,7	0,3				
40	0,9	0,4	0,2			
45	1,0	0,4	0,2			
50	1,2	0,5	0,3	0,2		
55	1,5	0,6	0,3			
60	1,8	0,8	0,4	0,3		
65	2,2	0,9	0,5	0,3		
70		1,0	0,5	0,3		
75		1,2	0,6	0,4		0,2
80		1,5	0,7	0,5	0,3	
85		1,7	0,8	0,5	0,3	
90		2,0	1,0	0,6	0,3	
95		2,2	2,2	1,1	0,7	0,4
100				1,3	0,8	0,4
105				1,5	0,9	0,5
110				1,7	1,1	0,5
115	2,0			1,2	0,6	
120	2,2	2,2	2,2	1,4	0,6	
125				1,6	0,7	
130				1,9	0,8	
135			2,1	2,1	0,9	
200					2,3	

Materials

Material quality

Part	Material
Rebar EN 1992-1-1	Bars and de-coiled rods class B or C with f_{yk} and k according to NDP or NCL of EN 1992-1-1 $f_{uk} = f_{tk} = k \cdot f_{yk}$

Fitness for use

Some creep tests have been conducted in accordance with ETAG guideline 001 part 5 and TR 023 in the following conditions: **in dry environment at 50 °C during 90 days.**

These tests show an excellent behaviour of the post-installed connection made with HIT-HY 200: low displacements with long term stability, failure load after exposure above reference load.

Resistance to chemical substances

Chemical	Resistance	Chemical	Resistance
Air	+	Gasoline	+
Acetic acid 10%	+	Glycole	o
Acetone	o	Hydrogen peroxide 10%	o
Ammonia 5%	+	Lactic acid 10%	+
Benzyl alcohol	-	Machinery oil	+
Chloric acid 10%	o	Methylethylketon	o
Chlorinated lime 10%	+	Nitric acid 10%	o
Citric acid 10%	+	Phosphoric acid 10%	+
Concrete plasticizer	+	Potassium Hydroxide pH 13,2	+
De-icing salt (Calcium chloride)	+	Sea water	+
Demineralized water	+	Sewage sludge	+
Diesel fuel	+	Sodium carbonate 10%	+
Drilling dust suspension pH 13,2	+	Sodium hypochlorite 2%	+
Ethanol 96%	-	Sulfuric acid 10%	+
Ethylacetate	-	Sulfuric acid 30%	+
Formic acid 10%	+	Toluene	o
Formwork oil	+	Xylene	o

- + resistant
- o resistant in short term (max. 48h) contact
- not resistant

Electrical Conductivity

HIT-HY 200 in the hardened state **is not conductive electrically**. Its electric resistivity is $15,5 \cdot 10^9 \Omega \cdot \text{cm}$ (DIN IEC 93 – 12.93). It is adapted well to realize electrically insulating anchoring (ex: railway applications, subway).

Setting information

Installation temperature range

-10°C to +40°C

Service temperature range

Hilti HIT-HY 200 injection mortar may be applied in the temperature ranges given below. An elevated base material temperature may lead to a reduction of the design bond resistance.

Temperature range	Base material temperature	Maximum long term base material temperature	Maximum short term base material temperature
Temperature range I	-40 °C to +80 °C	+50 °C	+80 °C

Max short term base material temperature

Short-term elevated base material temperatures are those that occur over brief intervals, e.g. as a result of diurnal cycling.

Max long term base material temperature

Long-term elevated base material temperatures are roughly constant over significant periods of time.

Curing and working time

Temperature of the base material	HIT-HY 200-A		HIT-HY 200-R	
	Maximum working time t_{work}	Minimum curing time t_{cure}	Maximum working time t_{work}	Minimum curing time t_{cure}
- 10°C < T_{BM} ≤ - 5°C	1,5 h	7 h	3 h	20 h
- 5°C < T_{BM} ≤ 0°C	50 min	4 h	2 h	8 h
0°C < T_{BM} ≤ 5°C	25 min	2 hour	1 h	4 h
5°C < T_{BM} ≤ 10°C	15 min	75 min	40 min	2,5 h
10°C < T_{BM} ≤ 20°C	7 min	45 min	15 min	1,5 h
20°C < T_{BM} ≤ 30°C	4 min	30 min	9 min	1 h
30°C < T_{BM} ≤ 40°C	3 min	30 min	6 min	1 h

Setting information

Installation equipment

Rebar – size	φ8 - φ16	φ18 - φ32
Rotary hammer	TE 2 (-A)– TE 40(-A)	TE40 – TE80
Other tools	Blow out pump ($h_{ef} \leq 10 \cdot d$)	-
	Compressed air gun ^{a)} Set of cleaning brushes ^{b)} , dispenser, piston plug	

a) Compressed air gun with extension hose for all drill holes deeper than 250 mm (for φ 8 to φ 12) or deeper than $20 \cdot \phi$ (for φ > 12 mm).

b) Automatic brushing with round brush for all drill holes deeper than 250 mm (for φ 8 to φ 12) or deeper than $20 \cdot \phi$ (for φ > 12 mm).

Minimum concrete cover c_{min} of the post-installed rebar

Drilling method	Bar diameter [mm]	Minimum concrete cover c_{min} [mm]	
		Without drilling aid	With drilling aid
Hammer drilling (HD) and (HDB)	φ < 25	$30 + 0,06 \cdot l_v \geq 2 \cdot \phi$	$30 + 0,02 \cdot l_v \geq 2 \cdot \phi$
	φ ≥ 25	$40 + 0,06 \cdot l_v \geq 2 \cdot \phi$	$40 + 0,02 \cdot l_v \geq 2 \cdot \phi$
Compressed air drilling (CA)	φ < 25	$50 + 0,08 \cdot l_v$	$50 + 0,02 \cdot l_v$
	φ ≥ 25	$60 + 0,08 \cdot l_v \geq 2 \cdot \phi$	$60 + 0,02 \cdot l_v \geq 2 \cdot \phi$

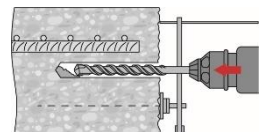

Drilling and cleaning diameters

Rebar [mm]	Hammer drill (HD)	Hollow Drill Bit (HDB) ^{b)}	Compressed air drill (CA)	Diamond coring with roughening tool (RT)	Brush HIT-RB	Air nozzle HIT-RB
	d ₀ [mm]				size [mm]	
φ8	12 / 10 ^{a)}	12	-	-	12 / 10 ^{a)}	12 / 10 ^{a)}
φ10	14 / 12 ^{a)}	14 / 12 ^{a)}	-	-	14 / 12 ^{a)}	14 / 12 ^{a)}
φ12	16 / 14 ^{a)}	16 / 14 ^{a)}	-	-	16 / 14 ^{a)}	16 / 14 ^{a)}
	-	-	17	-	18	16
φ14	18	18	17	18	18	18
φ16	20	20	-	-	20	20
	-	-	20	20	22	20
φ18	22	22	22	22	22	22
φ20	25	25	-	-	25	25
	-	-	26	25	28	25
φ22	28	28	28	28	28	28
φ24	32	32	32	32	32	32
φ25	32	32	32	32	32	
φ26	35	-	35	35	35	
φ28	35	-	35	35	35	
φ30	-	-	35	-	35	
	37	-	-	-	37	
φ32	40	-	40	-	40	

a) Maximum installation length l=250 mm.

Associated components for the use of Hilti Roughening tool TE-YRT

Diamond coring		Roughening tool TE-YRT	Wear gauge RTG...
d ₀ [mm]		d ₀ [mm]	size
Nominal	measured		
18	17,9 to 18,2	18	18
20	19,9 to 20,2	20	20
22	21,9 to 22,2	22	22
25	24,9 to 25,2	25	25
28	27,9 to 28,2	28	28
30	29,9 to 30,2	30	30
32	31,9 to 32,2	32	32
35	34,9 to 35,2	35	35

Installation parameters for use of the Hilti Roughening tool TE-YRT

h _{ef} [mm]	Minimum roughening time t _{roughen} [sec] (t _{roughen} [sec] = h _{ef} [mm] / 10)	Minimum blowing time t _{blowing} [sec] (t _{blowing} [sec] = t _{roughen} [sec] + 20)
0 to 100	10	30
101 to 200	20	40
201 to 300	30	50
301 to 400	40	60
401 to 500	50	70
501 to 600	60	80

Dispensers and corresponding maximum embedment depth $l_{v,max}$

Rebar	Dispenser	
	HDM 330, HDM 500, HDE 500	HDE 500
	Concrete temp. $\geq -10^{\circ}\text{C}$	Concrete temp. $\geq 0^{\circ}\text{C}$
	$l_{v,max}$ [mm]	$l_{v,max}$ [mm]
$\phi 8 - \phi 32$	700	1000

Setting instructions

*For detailed information on installation see instruction for use given with the package of the product.



Safety regulations.

Review the Material Safety Data Sheet (MSDS) before use for proper and safe handling! Wear well-fitting protective goggles and protective gloves when working with Hilti HIT-HY 200.

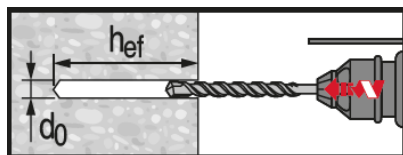

Hammer drilled hole (HD)

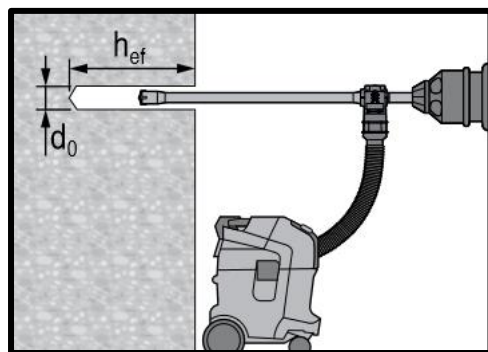

Hammer drilled hole with Hollow Drilled Bit (HDB)

No cleaning required

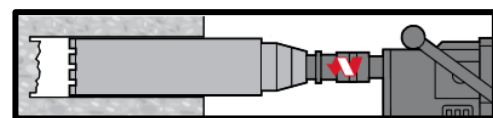

Diamond Drilling + Roughening Tool (DD+RT)

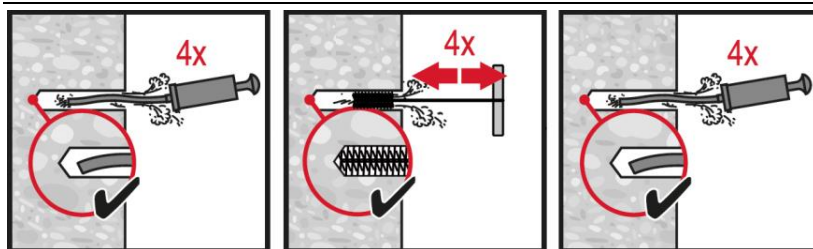
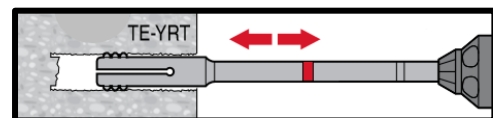

Hammer drilling:

Manual cleaning (MC)

for drill diameters $d_0 \leq 20$ mm and drill hole depth $h_0 \leq 10 \cdot d_0$.

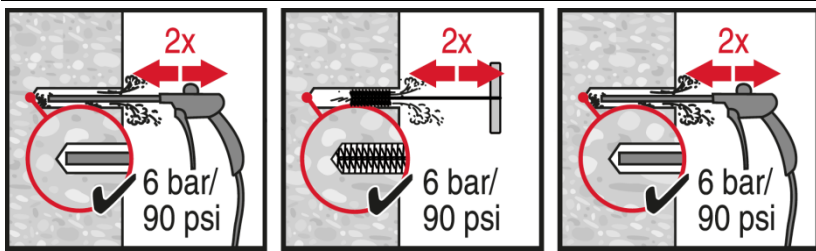

Hammer drilling:

Compressed air cleaning (CAC)

for all drill hole diameters d_0 and drill hole depths $h_0 \leq 20 \cdot d$.

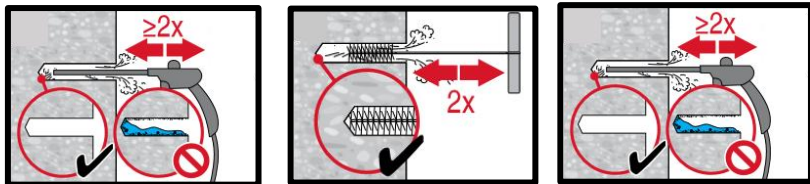

Diamond cored holes with Hilti roughening tool:

Compressed air cleaning (CAC)

for all drill hole diameters d_0 and drill hole depths h_0 .

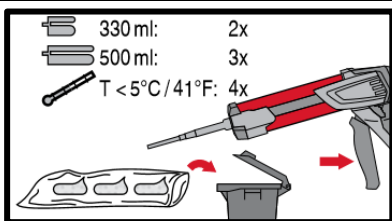
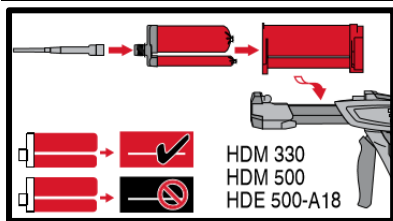

Injection system preparation.

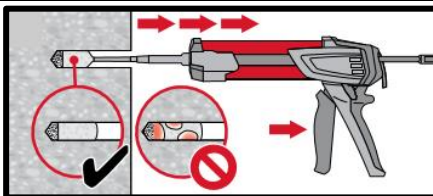
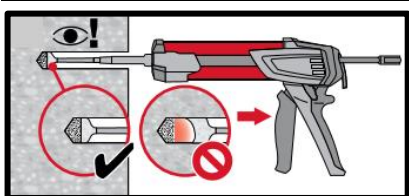

Injection method for drill hole depth $h_{ef} \leq 250$ mm.

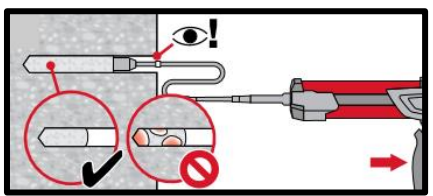
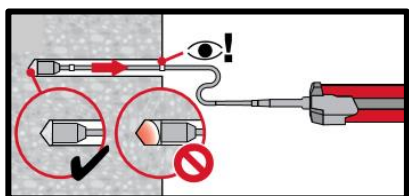

Injection method for drill hole depth $h_{ef} > 250$ mm.

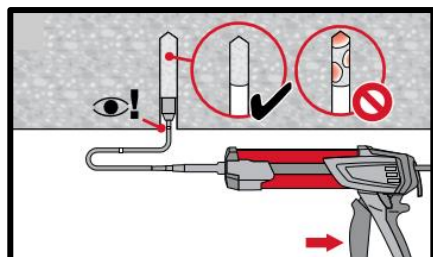
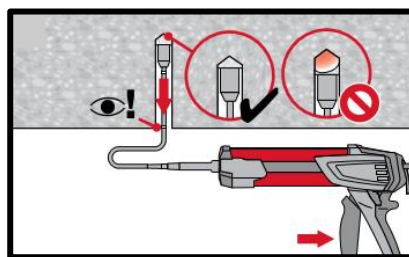

Injection method for overhead application.

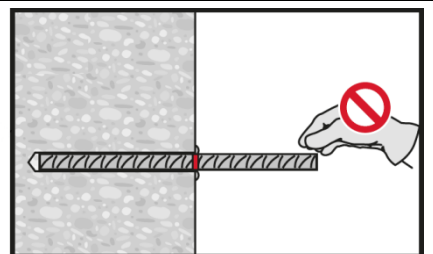
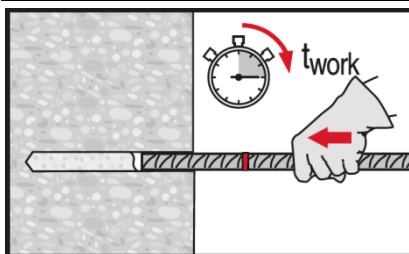

Setting element, observe working time "t_{work}".

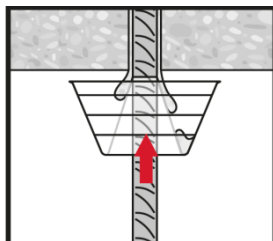
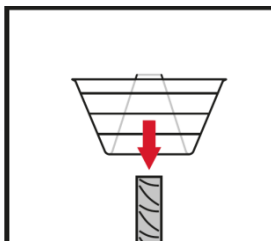
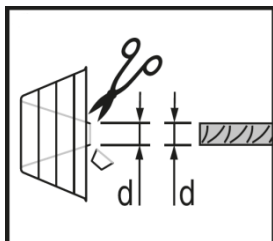

Setting element for overhead applications, observe working time "t_{work}".

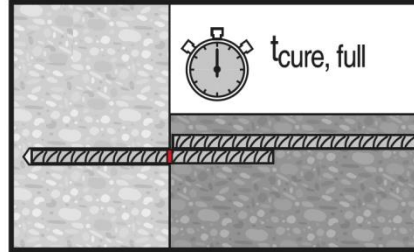
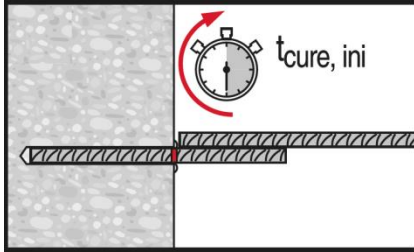
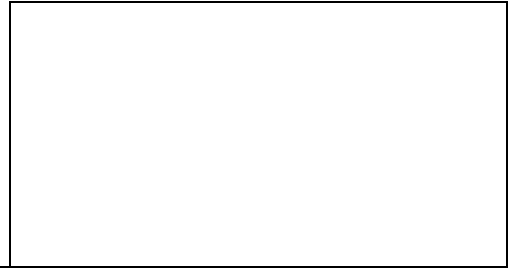
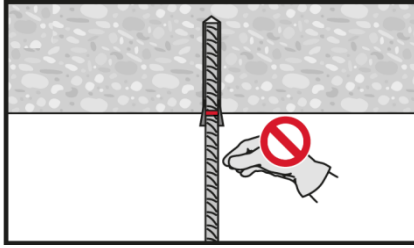
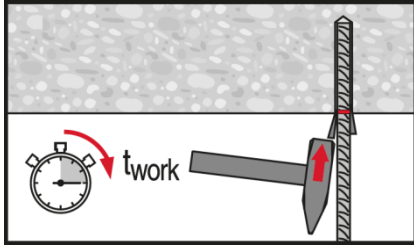

Apply full load only after curing time "tcure".

